



Lithium Smart Battery Manual

rev 14 - 09/2023

This manual is also available in [HTML5](#).

Table of Contents

1. Safety precautions	1
1.1. General warnings	1
1.2. Charge and discharge warnings	1
1.3. Transportation warnings	2
1.4. Disposal of lithium batteries	2
2. Introduction	3
2.1. Description	3
2.2. Features	3
3. System design and BMS selection guide	4
3.1. Maximum number of batteries in series, parallel or series/parallel configuration	4
3.2. The battery alarm signals and BMS actions	4
3.2.1. The pre-alarm signal	5
3.3. The BMS models	6
3.3.1. The Small BMS	7
3.3.2. The VE.Bus BMS V2	7
3.3.3. The VE.Bus BMS	8
3.3.4. The Lynx Smart BMS	9
3.3.5. The Smart BMS CL 12/100	9
3.3.6. The Smart BMS 12/200	10
3.4. Charging from an alternator	10
3.5. Battery monitoring	11
4. Installation	12
4.1. Unpacking and handling the battery	12
4.2. Download and install the VictronConnect app	12
4.2.1. Update the battery firmware	12
4.3. Initial charging before use	13
4.3.1. Why charge batteries before use	13
4.3.2. How to charge batteries before use	13
4.4. Mounting	14
4.5. Connecting battery cables	14
4.5.1. Cable cross-sectional area and fuse ratings	14
4.5.2. Connecting a single battery	14
4.5.3. Connecting multiple batteries in series	15
4.5.4. Connecting multiple batteries in parallel	15
4.5.5. Connecting multiple batteries in series/parallel	15
4.5.6. Battery banks consisting of different batteries	16
4.6. Connecting the BMS	16
4.7. Battery settings and configuration via VictronConnect	17
4.7.1. Battery settings	17
4.7.2. Battery temperature offset	17
4.7.3. Allowed-To-Charge minimum temperature	17
4.7.4. Cell under voltage pre-alarm threshold	17
4.7.5. Allowed-To-Discharge cell voltage	18
4.8. Charger settings	18
4.9. Commissioning	19
5. Operation	20
5.1. Setup, Monitoring & Control via VictronConnect	20
5.1.1. Battery Limits configuration	20
5.1.2. Monitoring the battery	20
5.1.3. Updating the battery firmware	20
5.2. Charging the battery and recommended charger settings	21
5.3. Discharging	22
5.4. Observe the operating conditions	22
5.5. Battery care	23
6. Troubleshooting & support	24
6.1. Battery issues	24
6.1.1. How to recognise cell imbalance	24

6.1.2. Causes for cell imbalance or a variation in cell voltages	24
6.1.3. How to recover an imbalanced battery	25
6.1.4. Less capacity than expected	25
6.1.5. Battery very low terminal voltage	26
6.1.6. Battery is close to end-of-cycle life or has been misused	27
6.2. BMS issues	28
6.2.1. The BMS frequently disables the battery charger	28
6.2.2. The BMS is prematurely turning chargers off	28
6.2.3. The BMS is prematurely turning loads off	28
6.2.4. The pre-alarm setting is missing in VictronConnect	28
6.2.5. The BMS is displaying an alarm while all cell voltages are within range	28
6.2.6. How to test if the BMS is functional	29
6.3. VictronConnect issues	30
6.3.1. Cannot connect with VictronConnect to the battery	30
6.3.2. Pin code lost	30
6.3.3. Interrupted firmware update	30
6.4. Warnings, alarms and errors	31
6.4.1. W-SL11: Under voltage warning (pre-alarm)	31
6.4.2. A-SL11: Under voltage alarm	31
6.4.3. A-SL9 Over voltage alarm	31
6.4.4. A-SL22: Under temperature alarm	31
6.4.5. A-SL15: Over temperature alarm	31
6.4.6. E-SL119: Settings data lost	31
6.4.7. E-SL24: Hardware failure	31
6.4.8. E-SL1: Balancer failure	32
6.4.9. E-SL2: Internal communication failure	32
6.4.10. E-SL9: Overlapped voltage error	32
6.4.11. E-SL10: Balancer update error	32
7. Technical data	33
8. Appendix	35
8.1. Initial charge procedure without BMS	35
8.2. Microcontroller power-cycle procedure	36
8.3. Cell balancing	39

1. Safety precautions



- Observe these instructions and keep them located near the battery for future reference.
- The Material Safety Datasheet can be downloaded from the “Material Safety Datasheet menu” located on the [Lithium Smart product page](#).
- Work on a lithium battery should be carried out by qualified personnel only.

1.1. General warnings

- While working on a lithium battery, wear protective eyeglasses and clothing.
- Any leaked battery material, such as electrolyte or powder on the skin or the eyes, must immediately be flushed with plenty of clean water. Then seek medical assistance. Spillages on clothing should be rinsed out with water.
- Explosion and fire hazard. In case of fire, you must use a type D foam or CO2 fire extinguisher.
- The terminals of a lithium battery are always live, therefore, do not place metallic items or tools on top of the battery.
- Use insulated tools.
- Do not wear any metallic items such as watches, bracelets, etc.
- Avoid short circuits, very deep discharges and excessive charge or discharge currents.



- Do not open or dismantle the battery. Electrolyte is very corrosive. In normal working conditions, contact with the electrolyte is impossible. If the battery casing is damaged, do not touch the exposed electrolyte or powder because it is corrosive.
- Lithium batteries are heavy. To avoid muscle strain or back injury, use lifting aids and proper lifting techniques when installing or removing batteries.
- If involved in a vehicle accident, they can become a projectile! Ensure adequate and secure mounting and always use suitable handling equipment for transportation.
- Handle with care because a lithium battery is sensitive to mechanical shock.
- Do not use a damaged battery.
- Water will damage your battery. Discontinue use and seek further advice.

1.2. Charge and discharge warnings



- Use only with a Victron Energy-approved BMS.
- Overcharge or discharge will seriously damage a lithium battery and may render the battery unsafe for continued use. Therefore, the use of an external safety relay is mandatory.
- If charged after the Lithium Battery was discharged below the “Discharge cut-off voltage”, or when the Lithium Battery is damaged or overcharged, the Lithium Battery can release a harmful mixture of gasses such as phosphate.
- The temperature range over which the battery can be charged is 5°C to 50°C. Charging the battery at temperatures outside this range may cause severe damage to the battery or reduce battery life expectancy.
- The temperature range over which the battery can be discharged is -20°C to 50°C. Discharging the battery at temperatures outside this range may cause severe damage to the battery or reduce battery life expectancy.

1.3. Transportation warnings



- The battery must be transported in its original or equivalent package and in an upright position. If the battery is in its cardboard packaging, use soft slings to avoid damage. Ensure that all packaging materials are non-conductive.
- Cartons or crates used to transport lithium batteries must have an approved warning label affixed.
- Air transportation of lithium batteries is prohibited.
- Do not stand below a battery when it is hoisted.
- Never lift the battery at the terminals or the BMS communication cables; only lift the battery at the handles.



- Batteries are tested according to UN Handbook of Tests and Criteria, part III, sub-section 38.3 (ST/SG/AC.10/11/Rev.5).
- For transport, the batteries belong to the category UN3480, Class 9, Packaging Group II and have to be transported according to this regulation. This means that for land and sea transport (ADR, RID & IMDG) they have to be packed according to packaging instruction P903 and for air transport (IATA) according to packaging instruction P965. The original packaging complies with these instructions.

1.4. Disposal of lithium batteries



- Do not throw a battery into fire.
- Batteries must not be mixed with domestic or industrial waste.
- Batteries marked with the recycling symbol  must be processed via a recognized recycling agency. By agreement, they may be returned to the manufacturer.

2. Introduction

2.1. Description

Victron Energy Lithium Smart batteries are Lithium Iron Phosphate (LiFePO₄ or LFP) batteries available with a nominal voltage of [12.8V or 25.6V in various capacities \[33\]](#).

This is the safest of the mainstream lithium battery types and is the battery chemistry of choice for very demanding applications.

2.2. Features

Integrated cell balancing, temperature and voltage control system

- The battery has an integrated balancing, temperature and voltage control system (BTV) that must be connected to an external battery management system (BMS). The BTV monitors each individual battery cell, balances the cell voltages and generates an alarm signal in case of high or low cell voltage or in case of high or low cell temperature. This alarm signal is received by the BMS (must be purchased separately, see the [The BMS models \[6\]](#) chapter for an overview of available BMS models and functionality), which then switches off the loads and/or chargers accordingly.

Setup, monitoring and control via Bluetooth and the VictronConnect App

- Battery setup, configuration and monitoring is done entirely via Bluetooth and the [VictronConnect app](#).
- View battery parameters such as cell status, voltages and temperature in real-time, configure the battery limits or update the battery firmware. Please see the [Battery settings and configuration via VictronConnect \[17\]](#) chapter for details.
- For details, please see the [Battery settings and configuration via VictronConnect \[17\]](#) chapter and get to know about the VictronConnect app and its functions. The VictronConnect manual can be downloaded from the [product page](#).

Up to 20 batteries can be series, parallel or series/parallel connected

- Victron Smart Lithium batteries can be connected in series, parallel and series/parallel so that a battery bank can be built for system voltages of 12V, 24V or 48V. The maximum number of batteries in one system is 20, which results in a maximum energy storage of 84kWh in a 12V system and up to 102kWh in a 24V and 48V system.

Other features

- High round-trip efficiency
- High energy density - More capacity with less weight and volume
- High charge and discharge currents, enabling fast charging and discharging

3. System design and BMS selection guide

This chapter describes things to consider on how the battery interacts with the BMS and how the BMS interacts with loads and chargers to keep the battery protected. This information is essential for system design and to be able to choose the most suitable BMS for the system.

3.1. Maximum number of batteries in series, parallel or series/parallel configuration

Up to 20 Victron Lithium Smart batteries in total can be used in a system, regardless of the Victron BMS used. This enables 12V, 24V and 48V energy storage systems with up to 102kWh (84kWh for a 12V system), depending on the capacity used and the number of batteries. See the [Installation \[12\]](#) chapter for installation details.

Check the table below to see how the maximum storage capacity can be achieved (using 12.8V/330Ah and 25.6V/200Ah batteries as an example):

System voltage	12.8V/330Ah	Nominal energy	25.6V/200Ah	Nominal energy
12V	20 in parallel	84kWh	na	na
24V	20 in 2S10P	84kWh	20 in parallel	102kWh
48V	20 in 4S5P	84kWh	20 in 2S10P	102kWh

3.2. The battery alarm signals and BMS actions

Cell voltages and battery temperature are monitored by the battery itself. If they are outside the normal range, an alarm is sent to the BMS.

In order to protect the battery, the BMS will then turn off loads and/or chargers or generate a pre-alarm as soon as it has received the appropriate signal from the battery.

These are the possible battery warnings and alarms and the corresponding BMS actions:

Battery alarm signal	BMS action
Low cell voltage pre-alarm warning	The BMS generates a pre-alarm signal
Low cell voltage alarm	The BMS turns loads off
High cell voltage alarm	The BMS turns chargers off
Low battery temperature alarm	The BMS turns chargers off
High battery temperature alarm	The BMS turns chargers off

The battery communicates these alarms to the BMS via its BMS cables.

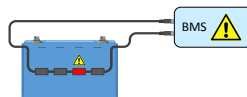

The BMS receives an alarm signal from a battery cell

If the system contains multiple batteries, all battery BMS cables are connected in series (daisy chained). The first and the last BMS cable is connected to the BMS.

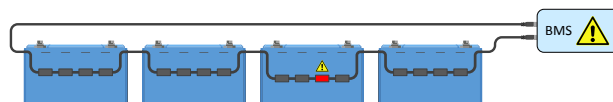

The BMS receives an alarm signal from a cell in a multiple-battery setup

The battery is equipped with 50 cm long BMS cables. If these cables are too short to reach the BMS, they can be extended with [BMS extension cables](#).

There are two ways the BMS can control loads and chargers:

1. By sending an electrical or digital on/off signal to the charger or load.
2. By physically connecting or disconnecting a load or a charge source from the battery. Either directly or by using a [BatteryProtect](#) or [Cyrix Li-ion relay](#).

All available BMS types for the lithium battery are based on either or both of these technologies. The BMS types and their functionality are briefly described in the next chapters.

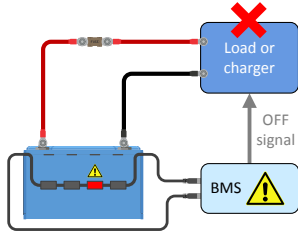

The BMS sends an on/off signal to a load or charger

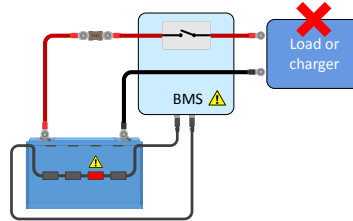

The BMS connects or disconnects from a load or charger

3.2.1. The pre-alarm signal

The purpose of the pre-alarm is to warn the user that the BMS is about to turn off the loads because one or more cells have reached the configurable (via VictronConnect) Cell under voltage pre-alarm threshold. For example; you would want an early warning that loads are going to be turned off while manoeuvring your boat, or if lights are turned off when it is dark. We recommend connecting the pre-alarm to a clearly visible or audible alarm device. When the pre-alarm is raised the user can turn on a charger to prevent the DC system from shutting down.

Switching behaviour



In case of an imminent under-voltage shutdown, the pre-alarm output of the BMS will switch on. In case the voltage continues to decrease, the loads are switched off (load disconnect) and at the same time, the pre-alarm output will switch off again. In case the voltage rises again (the operator has enabled a charger or has reduced the load) the pre-alarm output will switch off, once the lowest cell voltage has risen above 3.2V.



The BMS ensures a minimum delay of 30 seconds between enabling the pre-alarm and the load disconnect. This delay is to allow the operator a minimal amount of time to prevent the shutdown.

Please note that older batteries might not support pre-alarm.

3.3. The BMS models

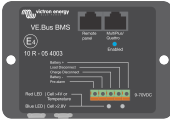
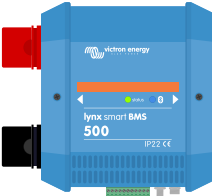
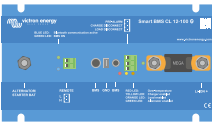
There is a choice of 7 different [BMS models](#) that can be used with the Lithium Smart Battery. The below overview explains the differences between them and their typical application. See also the [BMS Overview](#) for additional info.

BMS type	Voltage	Features	Typical application
 <p>SmallBMS</p>	12, 24 or 48V	<p>Controls loads and chargers via on/off signals.</p> <p>Generates a pre-alarm signal.</p> <p>Note: The smallBMS was previously named miniBMS.</p>	Small systems without inverter/chargers.
 <p>VE.Bus BMS V2</p>	12, 24 or 48V	<p>Controls MultiPlus or Quattro via VE.Bus.</p> <p>Controls loads and chargers via on/off signals.</p> <p>Generates a pre-alarm signal.</p> <p>Remote On/Off terminals</p> <p>Remote Panel port for communication with a GX device or DMC to control inverter/charger switch state (on/off/charger-only).</p> <p>Auxiliary power input and output terminals to power a GX device.</p>	Systems with inverter/chargers.
 <p>VE.Bus BMS</p>	12, 24 or 48V	<p>Controls MultiPlus or Quattro via VE.Bus.</p> <p>Controls loads and chargers via on/off signals.</p> <p>Generates a pre-alarm signal.</p>	Systems with inverter/chargers.
 <p>Lynx Smart BMS 500</p>	12, 24 or 48V	<p>Controls loads and chargers via on/off signals.</p> <p>Can control inverter/chargers, solar chargers and select AC chargers via DVCC.</p> <p>Generates a pre-alarm signal.</p> <p>500A contactor to disconnect system positive.</p> <p>Battery monitor.</p> <p>Bluetooth.</p> <p>Can connect to a GX device via VE.Can.</p> <p>Remote On/Off/Standby via VictronConnect app or a GX device.</p> <p>Installed in system positive and negative.</p> <p>Instant readout via Bluetooth</p>	<p>Larger systems with digital integration or when a built-in safety relay is needed.</p> <p>Also systems with inverter/chargers if GX device is present.</p>
 <p>Smart BMS CL 12/100</p>	12V	<p>100A dedicated alternator port.</p> <p>Controls loads and chargers via on/off signals.</p> <p>Generates a pre-alarm signal.</p> <p>Bluetooth.</p> <p>Installed in system positive.</p>	Relatively small systems with an alternator.

BMS type	Voltage	Features	Typical application
 <p>Smart BMS 12/200</p>	12V	100A dedicated alternator port. 200A dedicated DC system port. Controls loads and chargers via on/off signals. Generates a pre-alarm signal. Bluetooth. Installed in system positive.	Relatively small systems with an alternator and DC loads.
 <p>BMS 12/200</p>	12V	80A dedicated alternator port. 200A dedicated load and charger port. Installed in the system negative. Be aware that in many systems this is not ideal.	Relatively small systems with an alternator and DC loads but without inverter/charger. Note: This BMS is end of life, use a Smart BMS CL 12/100 or Smart BMS 12/200 instead.

3.3.1. The Small BMS

The smallBMS is equipped with a “load disconnect”, a “charge disconnect” and a pre-alarm contact.

- In the event of low cell voltage, the smallBMS will send a “load disconnect” signal to turn the load(s) off.
- Prior to turning the load off, it will send a pre-alarm signal indicating imminent low cell voltage.
- In the event of high cell voltage or low or high battery temperature, the smallBMS will send a “charge disconnect” signal to turn the charger(s) off.

For more information see the [smallBMS product page](#).

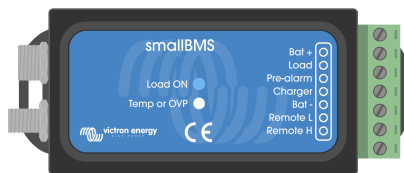

The smallBMS

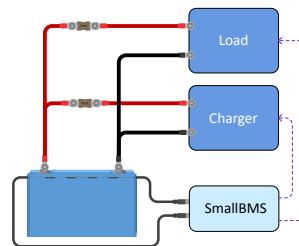

The smallBMS controls loads and chargers via “load disconnect” and “charge disconnect” signals

3.3.2. The VE.Bus BMS V2

The VE.Bus BMS V2 is the next generation of the VE.Bus Battery Management System (BMS). It is designed to interface with and protect a Victron Lithium Smart battery in systems that have Victron inverters or inverter/chargers with VE.Bus communication and offers new features such as auxiliary power in- and output ports for powering a GX device, remote on/off ports and communication with GX devices. It overcomes the limitations of its predecessor in switching the state of the inverter/charger remotely ie. via a GX device or a VE.Bus Smart dongle.

Just like the smallBMS, it also features a “load disconnect”, a “charge disconnect” and a “pre-alarm” contact.

- In the event of low cell voltage, the VE.Bus BMS V2 will send a “load disconnect” signal to turn off the load(s) and will also disable inverting of the inverter/charger via VE.Bus communication.
- Prior to turning loads off, it will send a pre-alarm signal warning of imminent low cell voltage.
- In the event of a high cell voltage or high/low battery temperature, the VE.Bus BMS V2 will send a “charge disconnect” signal to turn the charger(s) off and it will also disable the charger of the inverter/charger.

A mains detector and a short RJ45 UTP cable ship together with the VE.Bus BMS V2. These are needed for mains detection once the inverter/charger has been turned off by the BMS.



The mains detector is not needed for the MultiPlus-II or Quattro-II series of inverter/chargers.

For more information see the VE.Bus BMS V2 manual which can be found on the [VE.Bus BMS product page](#).

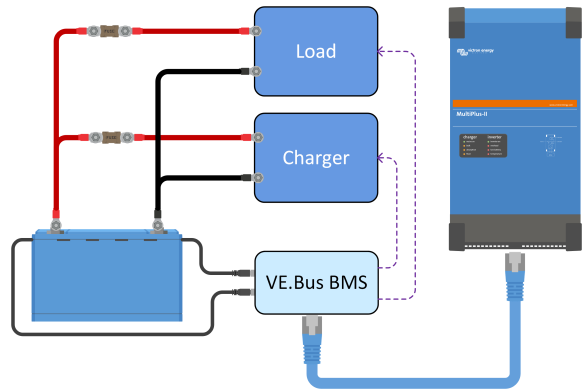
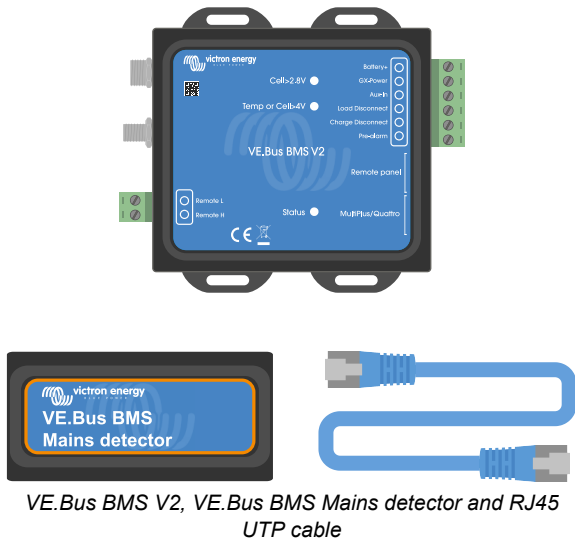

The VE.Bus BMS V2 will turn loads and chargers off via “load disconnect”, and “charge disconnect” and controls the inverter/charger

3.3.3. The VE.Bus BMS

The VE.Bus BMS is used in a system that also contains one or multiple Victron Energy inverter/chargers. The VE.Bus BMS directly communicates via the VE.Bus with the inverter/chargers. It also features a “load disconnect”, a “charge disconnect” and a “pre-alarm” contact.

- In the event of low cell voltage, the VE.Bus BMS will send a “load disconnect” signal to turn off the load(s) and it will also turn the inverter of the inverter/charger off.
- Prior to turning loads off, it will send a pre-alarm signal warning of imminent low cell voltage.
- In the event of a high cell voltage or high/low battery temperature, the VE.Bus BMS will send a “charge disconnect” signal to turn the charger(s) off and it will also turn the charger of the inverter/charger off.

A mains detector and a short RJ45 UTP cable ship together with the VE.Bus BMS. These are needed for mains detection once the inverter/charger has been turned off by the BMS.

 The mains detector is not needed for the MultiPlus-II or Quattro-II series of inverter/chargers.

For more information see the VE.Bus BMS manual which can be found on the [VE.Bus BMS product page](#).

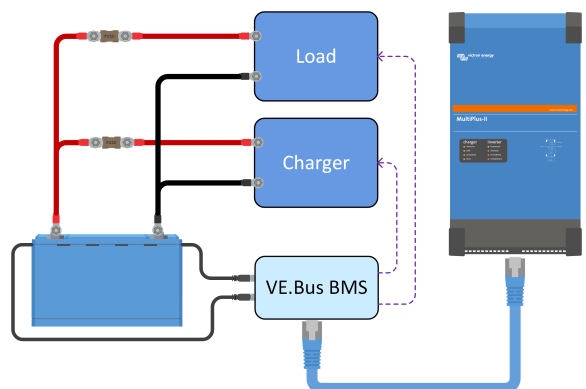
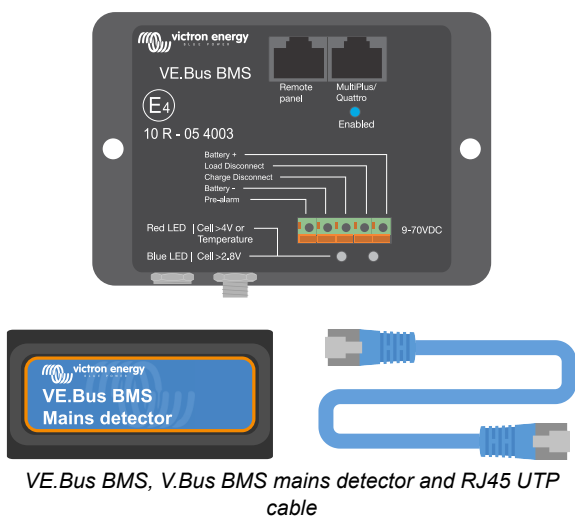

The VE.Bus BMS will turn loads and chargers off via “load disconnect”, and “charge disconnect” and controls the inverter/charger

3.3.4. The Lynx Smart BMS

The Lynx Smart BMS is used in medium to large systems that contain DC loads and AC loads via inverters or inverter/chargers, for example on yachts or in recreational vehicles. This BMS is equipped with a contactor that disconnects the DC system, a "load disconnect", a "charge disconnect", a "pre-alarm" contact and a battery monitor. In addition to this, it can be connected to a GX device and control Victron Energy equipment via DVCC.

- In the event of low cell voltage, the Lynx Smart BMS will send a "load disconnect" signal to turn the load(s) off.
- Prior to turning a load off, it will send a pre-alarm signal indicating imminent low cell voltage.
- In the event of high cell voltage or low/high battery temperature, the BMS will send a "charge disconnect" signal to turn the charger(s) off.
- If the batteries are even further discharged (or overcharged), the contactor will open, effectively disconnecting the DC system to protect the batteries.

For more information see the Lynx Smart BMS manual which can be found on the [Lynx Smart BMS product page](#).

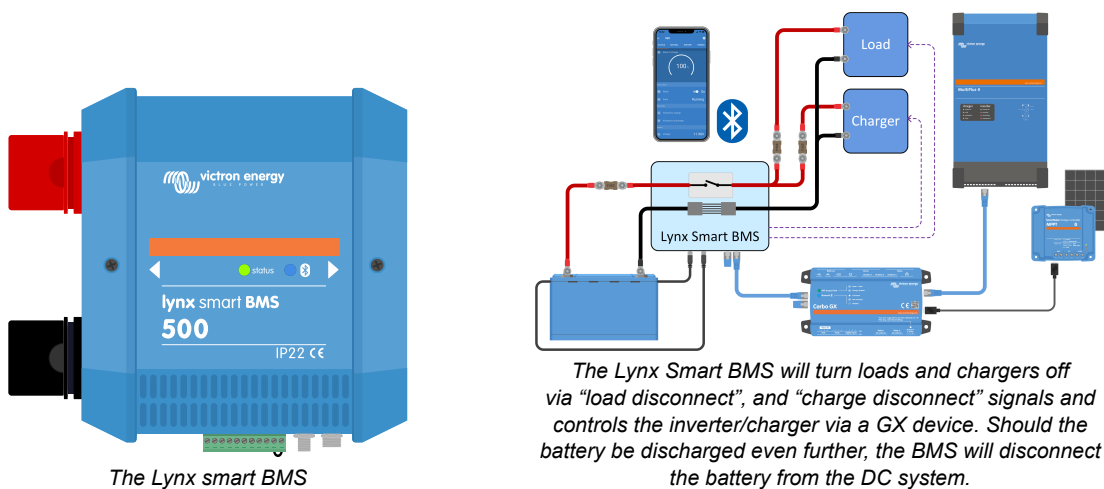

The Lynx smart BMS

3.3.5. The Smart BMS CL 12/100

The Smart BMS CL 12/100 is equipped with a "load disconnect", a "charge disconnect" and a "pre-alarm" contact. The BMS also features a dedicated alternator port that will "current limit" the alternator current. It can be set for a variety of currents all the way up to 100A.

- In the event of low cell voltage, the Smart BMS CL 12/100 will send a "load disconnect" signal to turn the load(s) off.
- Prior to turning the load off, it will send a pre-alarm signal indicating imminent low cell voltage.
- In the event of high cell voltage or low/high battery temperature, the Smart BMS CL 12/100 will send a "charge disconnect" signal to turn the charger(s) off.
- The alternator port controls and current limits the alternator.

For more information see the [Smart BMS CL 12/100 product page](#).

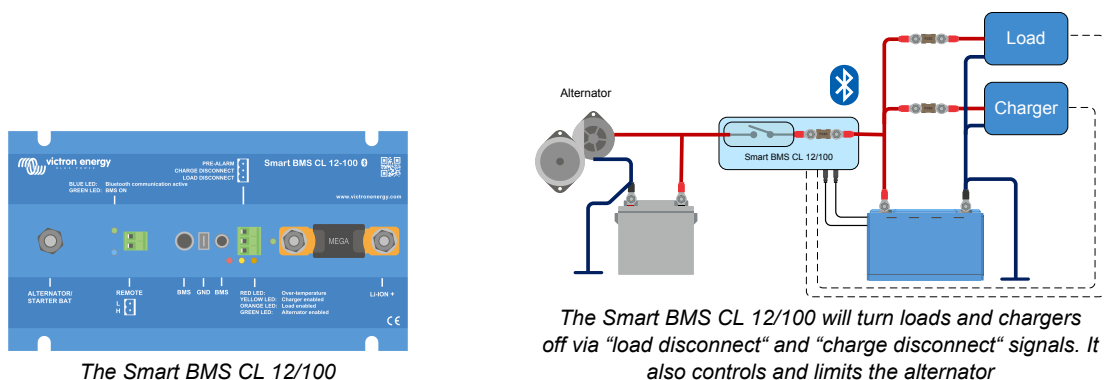

The Smart BMS CL 12/100

3.3.6. The Smart BMS 12/200

The Smart BMS 12/200 is equipped with a "load disconnect", a "charge disconnect" and a "pre-alarm" contact. The BMS also features a dedicated alternator and system port. The alternator port will "current limit" the alternator current. It can be set for a variety of currents all the way up to 100A. The system port is used to connect the DC system and can be used for both charging and discharging the battery.

- In the event of low cell voltage, the Smart BMS 12/200 will send a "load disconnect" signal to turn the load(s) off and will disconnect the System+ port.
- Prior to turning the load off, it will send a pre-alarm signal indicating imminent low cell voltage.
- In the event of high cell voltage or low/high battery temperature, the Smart BMS 12/200 will send a "charge disconnect" signal to turn the charger(s) off.
- The alternator port controls and current limits the alternator.

For more information see the [Smart BMS 12/200 product page](#).

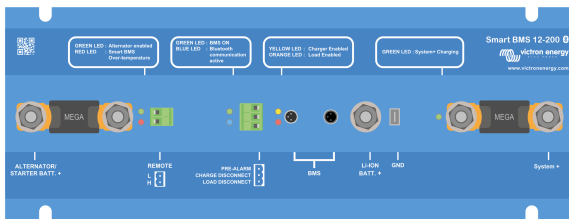

The Smart BMS 12/200

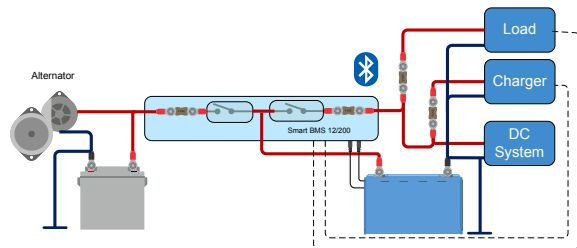

The Smart BMS 12/200 will disconnect loads and chargers or turn loads and chargers off via "load disconnect" and "charge disconnect" signals. It also controls and limits the alternator.

3.4. Charging from an alternator

Compared to lead-acid batteries, lithium batteries have a very low internal resistance and accept a much higher charging current. Special care must be taken to avoid overloading the alternator:

1. Make sure that the alternator current rating is at least twice the battery capacity rating. For example; a 400A alternator can be safely connected to a 200Ah battery.
2. Use an alternator equipped with a temperature-controlled alternator regulator. This prevents the alternator from overheating.
3. Use a current-limiting device like a DC-DC charger or a DC-DC converter between the alternator and the starter battery.
4. Use a BMS with an alternator port with built-in current limiting, such as the Smart BMS CL 12/100 or the Smart BMS 12/200.

For more information on charging lithium batteries with an alternator, see the [Alternator lithium charging blog and video](#).

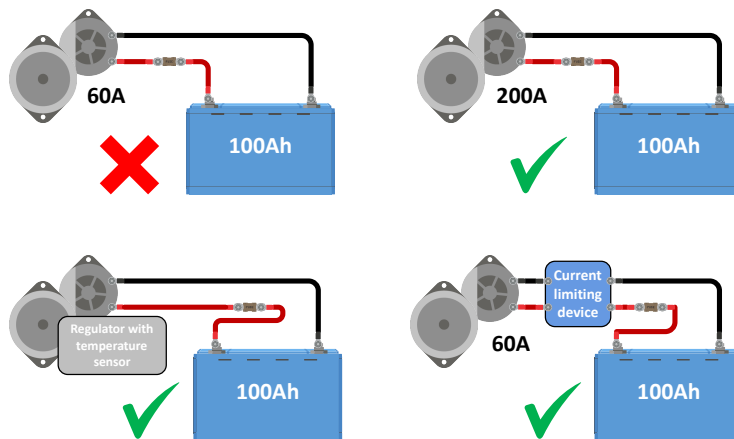

Alternator charging

3.5. Battery monitoring

The common battery parameters, such as the battery voltage, battery temperature and cell voltages can be monitored via Bluetooth using the VictronConnect app. **However, state of charge monitoring is not built into the battery.** To monitor state of charge use the [Lynx Smart BMS](#) or add a [battery monitor](#) such as a BMV or a SmartShunt to the system.

If a battery monitor is used together with a lithium battery, adjust the following two settings:

- Set the charge efficiency to 99%
- Set the Peukert exponent to 1.05

For more information on battery monitors, see the [Battery monitor product page](#).

When a battery monitor is added to the system, it is important how the battery monitor is powered. There are two options:

- **Power the battery monitor from the load disconnect terminal of the BMS:**

This is the preferred method. The battery cannot get accidentally discharged by the battery monitor. When the battery voltage is low and the BMS disconnects the loads, the battery monitor will also stop working. Once the battery is sufficiently charged, the battery monitor will automatically power back up. The battery monitor memory is non-volatile, which means that the battery monitor will keep its settings and history data when it is re-powered. The SoC will be reset to 100% once the battery has been fully recharged.

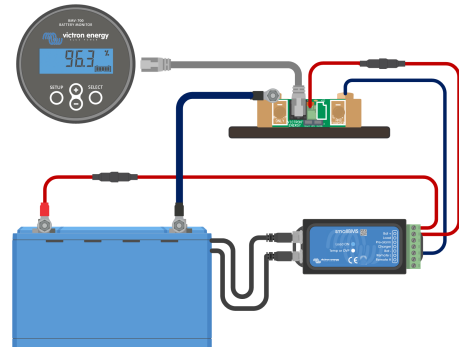

The battery monitor power wire is connected to the BMS

- **Power the battery monitor directly from the battery:**

This is not the preferred method, as it is only suitable for battery monitors with a low self-consumption such as the BMV-712 or the SmartShunt and the battery bank has to be larger than 200Ah. In a large battery bank, the battery monitor self-consumption is less significant.

If using this method, be aware that the battery monitor is not controlled by the BMS and that the battery monitor will continue to drain energy from the battery, even after the BMS has turned the loads off. The battery monitor can potentially totally discharge (and damage) the battery.

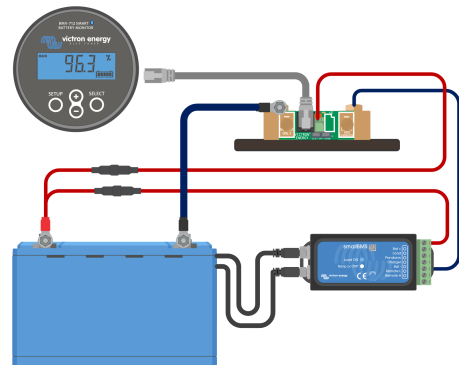

The battery monitor power wire is connected to the battery

4. Installation

4.1. Unpacking and handling the battery

Take care when unpacking the battery. Batteries are heavy. Do not lift the battery by its terminals or by its BMS cables. The battery has two carry handles on either side of the battery. The weight of the battery can be found in the [Technical data \[33\]](#) chapter.

Familiarise yourself with the battery. The main battery terminals on the top have a “+” symbol for positive and a “-” symbol for negative to ensure correct polarity.

Each battery has two BMS cables for communicating with the BMS. One cable has a male 3-pole connector, and the other has a female 3-pole connector. Depending on the battery model, the BMS cables are located on one side of the battery or two opposite sides of the battery.

Ensure that the BMS cables do not get snagged or damaged when handling the battery.

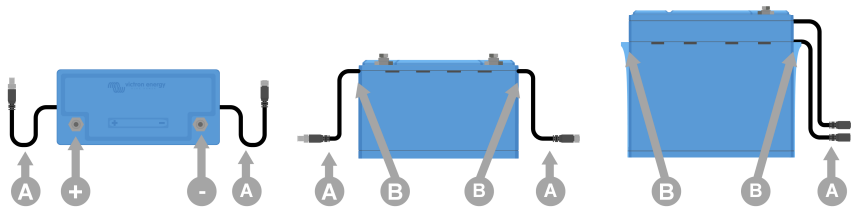

Top view and side views showing battery terminals (+ and -), BMS cables (A), and carry handles (B)

4.2. Download and install the VictronConnect app

Download the VictronConnect app for Android, iOS or macOS from their respective app stores. For more information about the app, see the [VictronConnect product page](#).

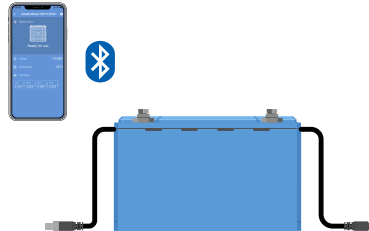



The VictronConnect app communicates with the battery via Bluetooth

4.2.1. Update the battery firmware

Before the battery is going to be used, it is important to check if the battery has the most up-to-date firmware. The firmware can be checked and updated with the VictronConnect app. Also, make sure you have the latest VictronConnect version. This ensures that the latest battery firmware version is available.

The VictronConnect app might ask, on first connection, to update the firmware. If this is the case, let it perform a firmware update. If it did not automatically update, check if the firmware is already up to date using the following procedure:

1. Connect to the battery
2. Click on the settings symbol  to go to the Settings page
3. Click on the option symbol  to go to the Product info
4. Check if you are running the latest firmware and look for the text: “This is the latest version”
5. If the battery does not have the most up-to-date firmware, perform a firmware update

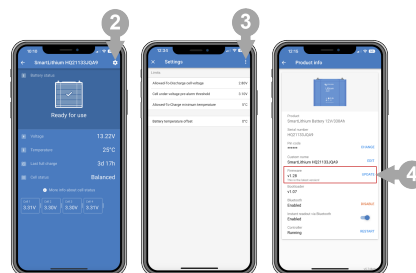

4.3. Initial charging before use

4.3.1. Why charge batteries before use

Lithium batteries are only approximately 50% charged when shipped from the factory. This is a transportation safety requirement. However, due to differences in transportation routes and warehousing, the batteries do not always have the same state of charge by the time they are installed.

The built-in battery cell balancing system is only able to correct small differences in state of charge from one battery to another. New batteries can have large state of charge differences between them that won't be corrected if installed that way, especially when connected in series. Please note that differences in state of charge between batteries is not the same thing as imbalances between cell voltages within a battery. This is because the cell balancing circuits in one battery cannot affect the cells in another battery. For more in-depth details on cell balancing refer to the [Cell balancing \[39\]](#) chapter.

4.3.2. How to charge batteries before use



Always use a BMS-controlled charger when individually charging lithium batteries.

If, for a specific reason, the initial charge procedure needs to be performed without a BMS (not recommended), check the [Initial charge procedure without BMS \[35\]](#) chapter in the appendix for details.

Initial charge procedure:

1. If a battery bank will consist of batteries connected in series to make a higher voltage bank, then each battery must be charged individually first. Use a dedicated charger or an inverter/charger with a BMS to perform the initial charge.
Only a single battery or a bank of parallel connected batteries can be charged as one.
Refer to the BMS manual on how to set the BMS up.
2. Set the charger to the charge profile as indicated in the [Charger settings \[18\]](#) section.
3. Ensure that the battery, the BMS and the charger are communicating with each other. Check this by disconnecting one of the battery BMS cables from the BMS and verifying that the charger turns off. Then reconnect the BMS cable and verify that the charger turns back on.
4. Turn the charger on and check that the charger is charging the battery.
Note that if, during charging, there is any imbalance between the battery cells then the BMS may turn the charger off and on repeatedly. You may notice that the charger is turned off for a few minutes and then on again for a short period of time before being turned off again. Don't be alarmed, this pattern will repeat itself until the cells are balanced. If the cells are balanced then the charger will not turn off until the battery is fully charged.
5. The battery is fully charged when the battery charger has reached the float stage and the VictronConnect app battery cell status is "balanced". In case the battery cell status is "unknown" or "imbalanced", then the battery charger will be restarted multiple times until the battery cell status is "balanced". The different statuses are described in the [Cell balancing \[39\]](#) chapter.

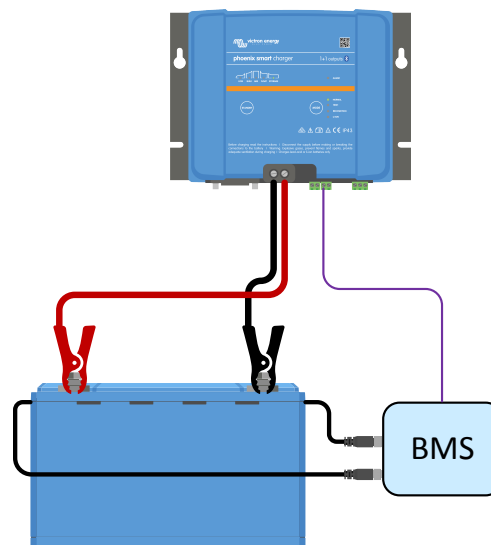

Initial charge using a BMS

4.4. Mounting

Mounting must meet the following requirements:

1. The battery must be mounted in an upright position.
2. The battery is only suitable for indoor use and needs to be installed in a dry location.
3. Batteries are heavy. When moving the battery into its destined location, use suitable handling equipment for transportation.
4. Ensure adequate and secure mounting, as the battery can become a projectile if involved in a vehicle accident.
5. Batteries produce a certain amount of heat when they are charged or discharged. Keep a 20mm space on all four sides of the battery for ventilation.

4.5. Connecting battery cables

Observe the battery polarity when connecting the battery terminals to a DC system or other batteries. Take care not to short-circuit the battery terminals.

Connect the cables as indicated in the diagram:

1. Bolt
2. Spring washer
3. Washer
4. Cable lug
5. Battery terminal

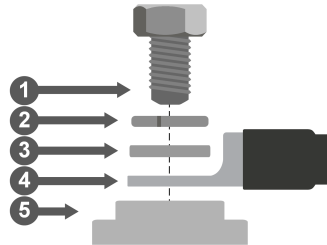

Battery cable connection

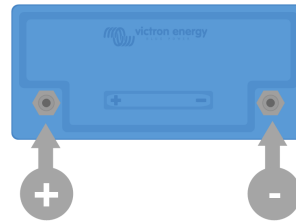

Battery terminals

When tightening the bolts, use the correct torque indicated in the table and use insulated tools that match the bolt head size.

Battery model	Thread	Torque
12.8V - 50Ah, 60Ah, 100Ah and 25.6V - 100Ah	M8	10Nm
12.8V - 160Ah, 200Ah and 25.6V - 200Ah	M8	14Nm
12.8V - 300Ah, 330Ah	M10	20Nm

4.5.1. Cable cross-sectional area and fuse ratings

Use battery cables with a cross-sectional area that matches the currents that can be expected in the battery system.

Batteries can produce very large currents; it is essential that all electrical connections to the battery are fused.

The battery cables must be sized to carry the maximum expected system current. An appropriately rated fuse for the battery cable size must be used.

For more information on cable cross-sectional area, fuse types and fuse ratings see the [Wiring Unlimited book](#).

The battery maximum discharge rating is indicated in the [Technical data \[33\]](#) table. The system current and therefore the fuse rating should not exceed this current rating. The fuse has to match the lowest current rating, that being the cable current rating, the battery current rating or the system current rating.

4.5.2. Connecting a single battery

- Fuse the battery on the positive side.
- Connect the battery to the DC system.

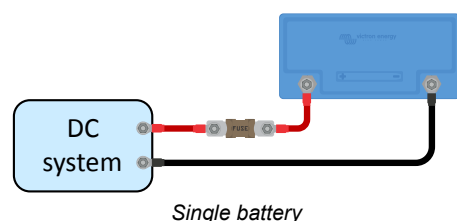

Single battery

4.5.3. Connecting multiple batteries in series

- Each individual battery needs to have been fully charged and balanced.
- Connect a maximum of four 12.8V batteries or a maximum of two 25.6V batteries in series.
- Connect the negative to the positive of the next battery.
- Fuse the series string on the positive side.
- Connect the battery bank to the system.

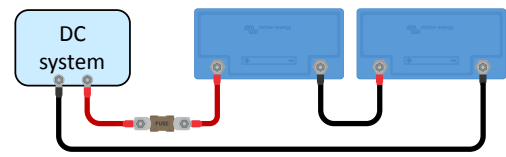

Multiple batteries in series

4.5.4. Connecting multiple batteries in parallel

- A total of 20 batteries can be connected in parallel.
- Fuse each battery on the positive side.
- Connect the DC system cables diagonally to ensure an equal current path through each battery.
- Take care that the cross-sectional area of the system cable is equal to the cross-sectional area of the string cable times the number of strings.
- Fuse the positive main cable going to the battery bank.
- Connect the battery bank to the DC system.
- See the [Wiring Unlimited book](https://www.victronenergy.com/upload/documents/Wiring-Unlimited-EN.pdf) for more information on constructing a parallel battery bank <https://www.victronenergy.com/upload/documents/Wiring-Unlimited-EN.pdf>.

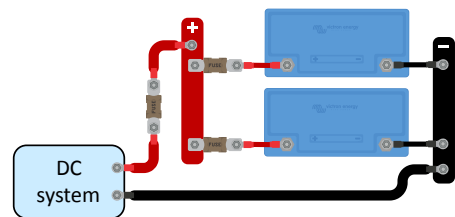

Multiple batteries in parallel

4.5.5. Connecting multiple batteries in series/parallel

- Connect a maximum of 20 batteries in a parallel/series combination.
- Each individual battery needs to have been fully charged and balanced.
- Fuse each series string on the positive side.
- Do not interconnect midpoints nor connect anything else at the midpoints.
- Connect the system cables diagonally to ensure an equal current path through each battery string.
- Take care that the cross-sectional area of the system cable is equal to the cross-sectional area of the string cable, times the number of strings.
- Fuse the positive main cable going to the battery bank.
- Connect the battery bank to the DC system.

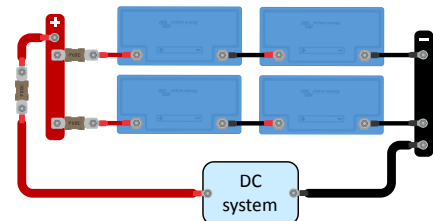

Multiple batteries in series/parallel

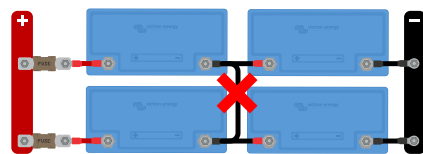

Do not interconnect midpoints nor connect anything else at the midpoints

4.5.6. Battery banks consisting of different batteries

When constructing a battery bank, ideally, all batteries should be of the same capacity, age and model. However, there are situations where this is not possible, such as when capacity needs to be expanded by adding more batteries or when a single battery in a battery bank needs to be replaced. In these cases, follow the guidelines in the table below.

Battery bank type	Different capacities allowed?	Different ages allowed?
Parallel	Yes	Yes
Series	No ¹⁾	Yes ²⁾
Series/parallel - within a series string	No ¹⁾	Yes ²⁾
Series/parallel - in case a whole series string is replaced or added	Yes	Yes

¹⁾ All batteries must have the same capacity rating and the same part number
²⁾ The age difference should not exceed 3 years

Background information:

Due to old batteries having reduced capacity, connecting them in series with new batteries or connecting different capacity batteries in series will result in an imbalance between the batteries. This imbalance will increase over time and cause an overall reduction in battery bank capacity. Theoretically, the battery with the lowest capacity would determine the overall capacity of a series string, but in reality, the overall series string capacity will reduce further over time. For example, if a 50Ah battery is connected in series with a 100Ah battery, the overall string capacity is 50Ah. But over time, the batteries become imbalanced, and when the imbalance has become, let's say, 10Ah, the overall battery capacity will be 50Ah-10Ah = 40Ah. The cells of the fullest battery will have an overvoltage during charging, while they are not able to send the excess voltage to the other battery cells. The BMS will constantly interfere, resulting in the emptiest battery is being discharged too deeply and the fullest battery is being overcharged.



Adding a [Battery Balancer](#) to a series string will reduce imbalance. This is the only time anything should be connected at battery interconnect points.

4.6. Connecting the BMS

Each battery has two BMS cables with an M8 male and M8 female connector that need to be connected to the BMS.

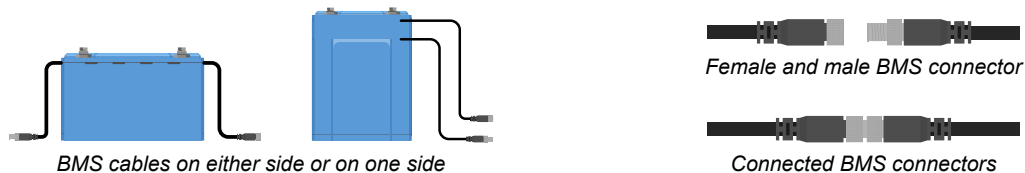

How to connect the cables:

- For a single battery, connect both BTV cables directly to the BMS.
- For a battery bank consisting of multiple batteries, interconnect each battery (daisy chain) and connect the first and last BTV cable to the BMS. The batteries can be interconnected in any order.
- If the BMS is too far away for the cables to reach, use the optional extension cables. The BTV extension cables are available as a pair and come in a variety of lengths. For more information see the [BTV extension cable product page](#).

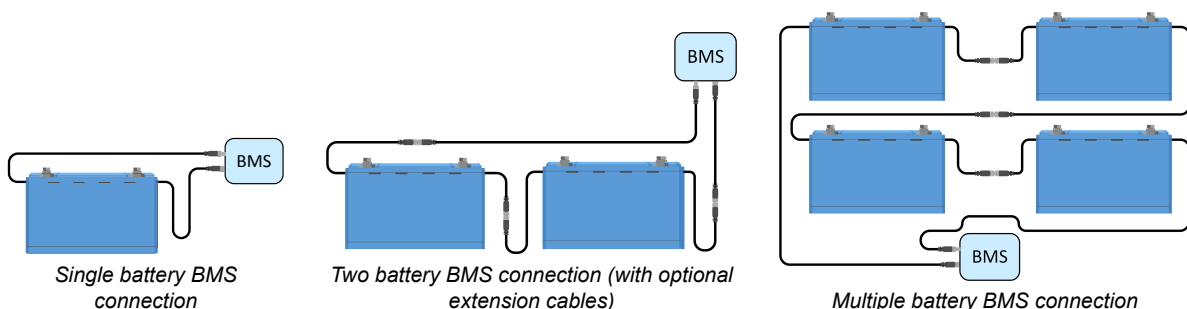

4.7. Battery settings and configuration via VictronConnect

4.7.1. Battery settings

The default settings in the battery are suitable for almost all applications. There is no need to change these settings unless the application requires very specific conditions.

If settings need to be changed, use the VictronConnect app. To access the settings, click on the settings symbol .

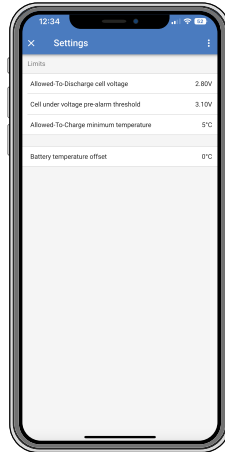

VictronConnect battery settings

4.7.2. Battery temperature offset

- This setting can be used to set an offset to improve the accuracy of the battery temperature measurement.
- The default value is 0°C, and the range is -10°C to +10°C.

4.7.3. Allowed-To-Charge minimum temperature

- This setting defines the lowest temperature at which the BMS allows battery charging.
- A lithium battery cell will sustain permanent damage when charged at temperatures below 5°C.
- The default value is 5°C and the range is -20°C to +20°C.



Setting this temperature below 5°C will void the warranty.

4.7.4. Cell under voltage pre-alarm threshold

- A pre-alarm signal is sent to the BMS when the cell voltage drops below this threshold. The purpose of the pre-alarm is to warn the user that the system is about to shut down due to undervoltage. For more details, see chapter [The pre-alarm signal \[5\]](#).
- The default value is 3.10 V, and the range is 2.80V to 3.15V.
- If the pre-alarm threshold is set at a higher voltage, the warning will come earlier than when set at a lower voltage. An earlier warning will give the user more time to take action and avert the imminent shutdown. In any case, there are at least 30 seconds between pre-alarm and system shutdown.

4.7.5. Allowed-To-Discharge cell voltage

A lithium battery cell will be damaged if the cell voltage drops too low. To avoid this, the BMS will disable all loads by sending a signal to the load or the load disconnection device as soon as one of the cells reaches the set Allowed-To-Discharge voltage threshold.

- Default value (the lowest battery cell voltage at which discharging the battery is disallowed): 2.80V (range 2.60 to 2.80V)
We recommend not to change this setting. The only scenario where a lower setting might be applicable is in emergency systems, where it could be a requirement to discharge the battery as far as possible and therefore sacrifice part of the battery's overall lifetime.

If the Allowed-To-Discharge cell voltage is set to a low value, there will be less reserve capacity than when it is set at a higher value, for example:

- At 2.8V cell voltage, the battery has approximately 3% remaining capacity.
- At 2.6V, there is about 1% remaining capacity in the battery.



More reserve capacity is important. When there is less reserve capacity, the battery will need to be recharged almost straight away after a low voltage shutdown has occurred. If the battery is not recharged, it will further discharge due to self-discharge and quickly reach the point where one or more cells are damaged due to low cell voltage. This will lead to a permanent reduction of battery capacity and/or lifetime.

4.8. Charger settings

The recommended charging parameters for the charging sources are:

- **For 12.8V models:** 14.20V absorption voltage, 2 hours absorption time and 13.50V float voltage
- **For 25.6V models:** 28.40V absorption voltage, 2 hours absorption time and 27.00V float voltage

For the recommended charge currents please see the [Charging the battery and recommended charger settings \[21\]](#) chapter and refer to the table in the [Technical data \[33\]](#) chapter.

For more information on the charging settings of the individual chargers or inverters/chargers, please refer to the manuals on the respective product page.

4.9. Commissioning

Once all connections have been made, the system wiring needs to be checked, the system needs to be powered up, and the BMS functionality needs to be checked. Follow this checklist:

- Check the polarity of all battery cables.
- Check the cross-sectional area of all battery cables.
- Check if all battery cable lugs have been crimped correctly.
- Check if all battery cable connections are tight (don't exceed maximum torque).
- Tug slightly on each battery cable and see if the connections are tight.
- Check all BMS cable connections and make sure the connector screw rings are screwed all the way down.
- Connect with VictronConnect to each battery.
- Check if each battery has the most up-to-date firmware.
- Check if each battery has the same settings.
- Connect the system positive and negative DC cable to the battery (or battery bank).
- Check the string fuse(s) rating (if applicable).
- Install the string fuse(s) (if applicable).
- Check the main fuse rating.
- Install the main fuse.
- Check if all battery charge sources have been set to the correct charge settings.
- Turn on all battery chargers and all loads.
- Check if the BMS is powered up.
- Disconnect a random BMS cable and verify that the BMS is turning off all charge sources and all loads.
- Reconnect the BMS cable and check if all charge sources and loads turn back on.

5. Operation

5.1. Setup, Monitoring & Control via VictronConnect

Setup, monitoring and control are done entirely via Bluetooth using the VictronConnect app.

5.1.1. Battery Limits configuration

The individual parameters for the battery limits are explained in the chapter [Battery settings and configuration via VictronConnect \[17\]](#). It is recommended to leave these parameters at their default settings.

5.1.2. Monitoring the battery

The VictronConnect app can be used to monitor the battery via Bluetooth in two ways:

1. Via a connected Bluetooth link to the battery: requires pairing between the mobile device and the battery.
2. Via Instant readout: show the most relevant data of the battery in the product list page via Bluetooth without having to establish a connection.

Paired Bluetooth connection

When connected to the battery via VictronConnect, it will show the following parameters:

- Battery status
- Battery voltage
- Battery temperature
- Time since last full battery charge
- Cell balance status
- Individual cell voltage

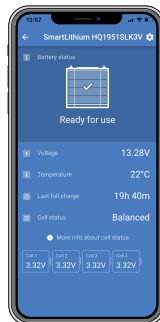

Paired connection

Note that warning, alarm or error messages are only shown while actively connected to the battery via VictronConnect. The app is not active in the background nor when the screen is off.

Instant readout

Instant readout via Bluetooth offers the advantage that the most important data is shown instantly in the VictronConnect app (together with data of other devices that are compatible), without having to connect directly to the battery. In addition, it offers a better range than a regular connection.

Instant readout is disabled by default and can be enabled in the product info page. See also the chapter [Instant readout](#) in the VictronConnect manual.

Instant readout will show the following parameters:

- Battery voltage and temperature
- Cell balance status
- Highest, average and lowest cell voltage
- Warning, alarm and error messages

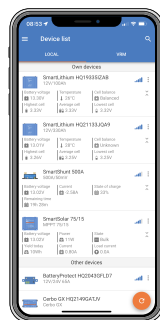

Instant readout

5.1.3. Updating the battery firmware

Please see the chapter [Update the battery firmware \[12\]](#) for details.

5.2. Charging the battery and recommended charger settings

Recommended battery chargers

Ensure your charger supplies the correct current and voltage for the battery, so do not use a 24V charger for a 12V battery.

It is also recommended that the charger has a charging profile/algorithm that matches the battery chemistry (LiFePO₄) or a custom profile that can be adjusted to match the appropriate charging parameters of the lithium battery. All Victron chargers ([AC Chargers](#) including [Inverter/Chargers](#), [Solar Chargers](#) and [DC-DC Chargers](#)) have these preset charging profiles built-in. Make sure this profile is selected. See also the respective manuals of the chargers.

Recommended charger settings

The important charging parameters are absorption voltage, absorption time and float voltage.

- **Absorption voltage:** 14.2V for a 12.8V lithium battery (28.4V / 56.8V for a 24V or 48V system)
- **Absorption time:** 2 hours. We recommend a minimum absorption time of 2 hours per month for lightly cycled systems, such as backup or UPS applications and 4 to 8 hours per month for more heavily cycled (off-grid or ESS) systems. This allows the balancer enough time to properly balance the cells. Please see the [Cell balancing \[39\]](#) chapter for a more detailed explanation why cell balancing is needed and how cell balancing works.
- **Float voltage:** 13.5V for a 12.8V lithium battery (27V / 54V for a 24V or 48V system)

Some charging profiles offer a storage mode. This is not needed for a lithium battery, but if the charger has a storage mode then set this to the same value as the float voltage.

Some chargers have a bulk voltage setting. If this is the case, set the bulk voltage to the same value as the absorption voltage.

Temperature-compensated charging is not required for lithium batteries; Disable temperature compensation or set temperature compensation to 0mV/°C in your battery chargers.

Recommended charging current

Even if the battery can be charged with a much higher charging current (see the [Technical data \[33\]](#) for the max. continuous charge current), we recommend a charging current of 0.5C, which will fully recharge a completely empty battery in 2 hours. A charging current of 0.5C for a 100Ah battery corresponds to a charging current of 50A.

Charging profile

A typical charging profile resulting from the above then looks like the graph below:

- After starting the charger, it takes two hours to reach absorption voltage
- Another two hours of absorption time to give the balancer time to balance the cells properly
- At the end of the absorption time, the charging voltage is reduced to 13.5 V float voltage

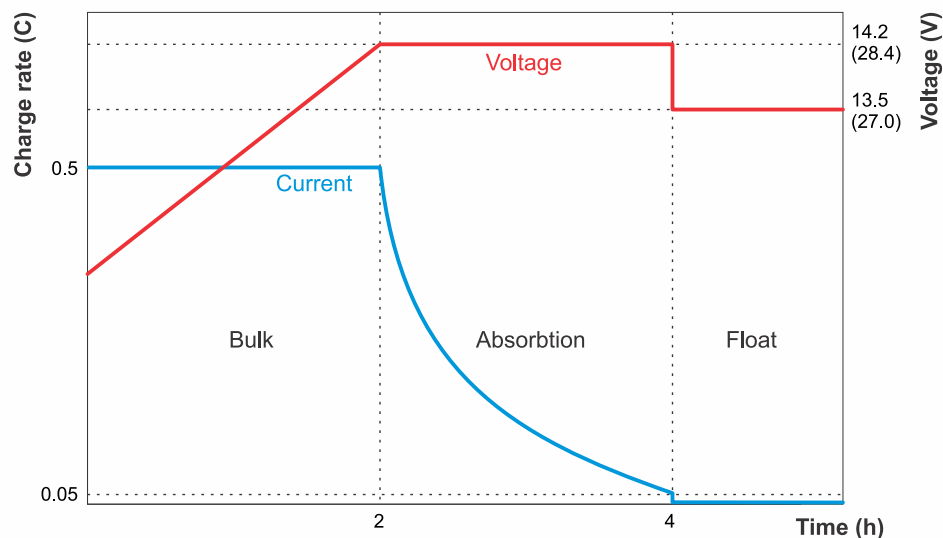

Lithium battery charge graph

5.3. Discharging

Even though a BMS is used, there are still a few possible scenarios where the battery can be damaged due to over-discharge. Be sure to observe the following warning.



Lithium batteries are expensive and can be damaged due to over-discharge or overcharge.

Damage due to over-discharge can occur if small loads (such as alarm systems, relays, standby current of certain loads, back current drain of battery chargers, or charge regulators) slowly discharge the battery when the system is not in use.

A shutdown due to a low cell voltage by the BMS should always only be used as a last resort to prevent imminent battery damage. We recommend not letting it get that far in the first place and instead using the remote on/off function of the BMS as a system on/off switch when you leave the system unattended for extended periods of time, or even better, using a battery switch, pulling the battery fuse(s) or disconnection the battery positive terminal when the system is not in use. Before doing this, make sure that the battery is sufficiently charged so that there is always enough reserve capacity in the battery.

A residual discharge current is especially dangerous if the system has been discharged completely and a low cell voltage shutdown has occurred. After shutdown due to low cell voltage, a capacity reserve of approximately 1Ah per 100Ah battery capacity is left in the battery. The battery will be damaged if the remaining capacity reserve is drawn from the battery, for example, a residual current of just 10mA can damage a 200Ah battery if the system is left discharged for more than 8 days.

Immediate action (recharge the battery) is required if a low cell voltage disconnect has occurred.

Recommended discharge current

We recommend a continuous discharge current of $\leq 1C$ even if the maximum allowed discharge current is much higher (see [Technical data \[33\]](#)). When using a higher discharge rate, the battery will produce more heat than when a low discharge rate is used. More ventilation space is needed around the batteries and depending on the installation, hot air extraction or forced air cooling might be required. Also, some cells might reach the low voltage threshold quicker than other cells. This can be because of a combination of elevated cell temperature and battery ageing.

Depth of Discharge (DoD)

The depth of discharge has a decisive influence on the service life of the lithium battery. The higher the depth of discharge, the lower the number of possible charge cycles. See the [Technical data \[33\]](#) for the possible number of charge cycles depending on the depth of discharge.

Effect of temperature on battery capacity

The temperature affects the battery capacity. The nominal capacity data of the respective battery model in the datasheet is based on 25°C at a discharge rate of 1C. These numbers are reduced by ~20% at 0°C and reduce even further to ~50% at -20°C. However, since SoC is not calculated in the battery but in the battery monitor, which therefore does not show the actual SoC, it is much more important to keep an eye on the battery and cell voltages when discharging at low temperatures.

5.4. Observe the operating conditions

The operating conditions for charging and discharging the battery must also be observed.

These are in detail:

- Discharge is only permitted in a temperature range of -20°C to +50°C.
Ensure that all loads are switched off accordingly when the temperature exceeds the limits (ideally loads have a remote on/off port controlled by the BMS).
- Charging the battery is only allowed in a temperature range of +5°C to +50°C.
Ensure that all chargers are switched off accordingly when the Allowed-To-Charge minimum temperature limit is reached (ideally the charger has a remote on/off port controlled by the BMS) to prevent charging below +5°C or above 50°C.

5.5. Battery care

Once the battery is in operation, it is important to take proper care of the battery to maximise its lifetime.

These are the basic guidelines:

1. Prevent total battery discharge at all times.
2. Familiarise yourself with the pre-alarm feature and act when the pre-alarm is active to prevent a system shutdown.
3. If the pre-alarm is active or if the BMS has disabled the loads, make sure that the batteries are recharged immediately. Minimise the time the batteries are in a deep discharged state.
4. The batteries must spend at least 2 hours in absorption charge mode each month to ensure sufficient time in balancing mode. For detailed information on how the balancing process works, see the [Cell balancing \[39\]](#) chapter.
5. When leaving the system unattended for some time, make sure to either keep the batteries charged during that time or make sure the batteries are (almost) full and then disconnect the DC system from the battery.

6. Troubleshooting & support

The first step of the troubleshooting process should be to follow the steps in this chapter for common battery issues.

If you experience problems with VictronConnect, first consult the [VictronConnect manual](#), especially the troubleshooting chapter.

Should all this fail to resolve the issue, scan through popular questions and answers regarding your product and ask the community of experts in the [Victron Community](#). In case the problem persists, contact the point of purchase for technical support. If the point of purchase is unknown, refer to the [Victron Energy Support webpage](#).

6.1. Battery issues

6.1.1. How to recognise cell imbalance

- The BMS frequently disables the charger

This is an indication that the battery is imbalanced. The charger will never be disabled by the BMS if the battery is well-balanced. Even when fully charged, the BMS will leave the charger enabled.

- The battery capacity seems to be less than before

If the BMS is disabling loads much sooner than it used to do, even while the overall battery voltage still looks OK, this is an indication that the battery is imbalanced.

- There is a noticeable difference between the individual cell voltages during absorption stage

When the charger is in the absorption stage, all cell voltages should be equal and between 3.50V and 3.60V. If this is not the case, this is an indication that the battery is imbalanced.

- A cell slowly drops in voltage when the battery is not used

This is not an imbalance, although it might look like it. A typical example of this is when the battery cells initially all have equal voltages, but when the battery is not used after a day or so, one of the cells has dropped 0.1 to 0.2V below the other cells. This cannot be fixed by rebalancing and the cell is considered to be defective.

6.1.2. Causes for cell imbalance or a variation in cell voltages

1. ***The battery has not spent enough time in the absorption charge stage.***

This can, for example, happen in a system where there is not enough solar power to fully charge the battery, or in systems where the generator is not running long or often enough. During normal operation of a lithium battery, small differences between cell voltages occur all the time. These are caused by slight differences between the internal resistance and self-discharge rates of each cell. The absorption charge stage fixes these small differences. We recommend a minimum absorption time of 2 hours per month for lightly cycled systems, such as backup or UPS applications and 4 to 8 hours per month for more heavily cycled (off-grid or ESS) systems. This allows the balancer enough time to properly balance the cells.

2. ***The battery never reaches the float (or storage) stage.***

The float (or storage) stage follows the absorption stage. During this stage, the charge voltage drops to 13.5V and the battery can be considered full. If the charger never enters this stage, it might be a sign that the absorption stage has not been completed (see previous point). The charger should be allowed to reach this stage at least once a month. This is also needed for battery monitor SoC (state of charge) synchronization.

3. ***The battery has been discharged too deeply.***

During a very deep discharge, one or more cells in the battery can drop well below their low voltage thresholds. The battery might be recoverable by rebalancing, but there is also a realistic chance that one or more cells are now defective and that rebalancing will not be successful. Consider the cell to be defective. This is not covered by warranty.

4. ***The battery is old and is near to its maximum cycle life.***

When the battery is close to its maximum cycle life, one or more battery cells will start to deteriorate, and the cell voltage will be lower than the other cell voltages. This is not an imbalance, although it might look like it is. This cannot be fixed by rebalancing. Consider the cell defective. This is not covered by warranty.

5. ***The battery has a defective battery cell.***

A cell can become defective after a very deep discharge when it is at the end of its cycle life or because of a manufacturing fault. A defective cell is not unbalanced (although it might look like it is). It cannot be fixed by rebalancing. Consider the cell defective. Very deep discharge and end-of-cycle life are not covered by warranty.

6.1.3. How to recover an imbalanced battery

- Charge the battery using a charger configured for lithium and controlled by the BMS.
- Be aware that cell balancing only takes place during the absorption stage. It will be necessary to manually restart the charger each time the charger has gone to float. Rebalancing can take a long time (up to a few days) and require many manual charger restarts.
- Be aware that it might look like nothing is happening during cell balancing. The cell voltages can remain the same for a long time, and the BMS will repeatedly turn the charger on and off. This is all normal.
- Balancing is taking place when the charge current is at or above 1.8A or when the BMS has temporarily disabled the charger.
- Balancing is almost finished when the charge current drops below 1.5A and the cell voltages are close to 3.55V.
- The rebalancing process is complete when the charge current has dropped even further and all cells are 3.55V.



Be 100% sure that the BMS controls the charger; dangerous cell overvoltage can occur if it is not. Check this by monitoring the cell voltages using the VictronConnect app. The voltage of the fully charged cells will slowly creep up until 3.7V has been reached. At this point, the BMS will disable the charger and the cell voltages will drop again. This process will continuously repeat until the balance is restored.

Calculation example of time required to restore a heavily imbalanced battery:

Imagine a 12.8V 200Ah battery with one heavily undercharged (discharged) cell for this example.

A 12.8V battery contains 4 cells, each having a nominal voltage of 3.2V. And they are connected in series. This results in $3.2 \times 4 = 12.8V$. Just like the battery, each cell has a capacity of 200Ah.

Let's say the imbalanced cell is only at 50% of its capacity while the other cells are fully charged. The rebalancing process will need to add 100Ah to that cell to restore the balance.

The balancing current is 1.8A (per battery and all battery sizes, except for the 12.8V/50Ah model, which has a balancing current of 1A). Rebalancing the cell will take at least $100/1.8 = 55$ hours.

Balancing only takes place when the charger is in the absorption stage. If a 2-hour lithium charge algorithm is used, the charger will need to be manually restarted $55/2=27$ times during the rebalancing process. If the charger is not restarted immediately, the balancing process will be delayed, and this will add to the total balancing time.



A tip for Victron Energy distributors and professional users: To avoid having to restart the charger continuously, use the following trick. Set the float voltage at 14.2, this will have the same effect as the absorption stage. Also, disable the storage stage and/or set that to 14.2V. Or alternatively, set the absorption time to a very long time. What matters is that the charger maintains a continuous 14.2V charge voltage during the rebalancing process. After the battery has been rebalanced, set the charger back to the normal lithium charge algorithm. Never leave a charger connected like this in a running system. Keeping the battery at such a high voltage will decrease the lifetime of the battery.

6.1.4. Less capacity than expected

If the battery capacity is less than its rated capacity, these are the possible reasons for that:

- The battery has a cell imbalance, causing premature low-voltage alarms, which in turn causes the BMS to turn loads off. Please refer to section [How to recover an imbalanced battery \[25\]](#).

- The battery is old and is near its maximum cycle life.

Check how long the system has been in operation, how many cycles the battery has gone through and to what average depth of discharge the battery has been discharged. A way to find this information is to look at the history of a battery monitor (if available).

- The battery has been discharged too deeply, and one or more cells in the battery are permanently damaged.

These bad cells will have a low cell voltage faster than the other cells, and this will cause the BMS to turn loads off prematurely. Has the battery perhaps been through a very deep discharge event?

6.1.5. Battery very low terminal voltage

If the battery has been discharged too deeply, the voltage will fall well below 12V (24V). If the battery has a voltage of less than 10V (20V) or if one of the battery cells has a cell voltage below 2.5V, the battery will have permanent damage. This will invalidate the warranty. The lower the battery or cell voltage is, the more damage to the battery will be.

If the voltage has dropped below 8V, the battery will not communicate via Bluetooth anymore. The Bluetooth module is turned off when the battery terminal voltage drops below 8V or if a cell voltage drops below 2V.

You can try to recover the battery by using the below low-voltage recharge procedure. Be aware that this is not a guaranteed process, recovery might be unsuccessful, and there is a realistic chance that the battery has permanent cell damage resulting in a moderate to severe capacity loss after the battery has been recovered.

Charge procedure for recovery after low voltage event:

This recovery charge procedure can only be performed on an individual battery. If the system contains multiple batteries, repeat this procedure for each individual battery.



This process can be risky. A supervisor must be present at all times.

1. Set a charger or power supply to 13.8V (27.6V).
2. In case any of the cell voltages is below 2.0V, charge the battery with 0.1A until the voltage of the lowest cell increases to 2.5V.
A supervisor must monitor the battery and stop the charger as soon as the battery is getting hot or bulging. If this is the case, the battery is unrecoverably damaged.
3. Once the voltage of the lowest cell has increased above 2.5V, increase the charge current to 0.1C.
For a 100Ah battery, this is a charge current of 10A.
4. Connect the battery to a BMS and ensure that the BMS has control over the battery charger.
5. Make a note of the initial battery terminal voltage and battery cell voltages.
6. Start the charger.
7. The BMS might turn the charger off, then on again for a short time and then off again.
This can occur many times over and is normal behaviour in case there is a significant cell imbalance.
8. Make a note of the voltages at regular intervals.
9. The cell voltages should increase during the first part of the charging process.
If the voltage of any of the cells does not increase in the first half hour, consider the battery unrecoverable and abort the charging procedure.
10. Check the battery temperature at regular intervals.
If you see a sharp increase in temperature, consider the battery unrecoverable and abort the charging procedure.
11. Once the battery has reached 13.8V (27.6V), increase the charge voltage to 14.2V (28.4V) and increase the charge current to 0.5C.
For a 100Ah battery, this is a charge current of 50A.
12. The cell voltages will increase more slowly, this is normal during the middle part of the charge process.
13. Leave the charger connected for 6 hours.
14. Check the cell voltages, they should all be within 0.1V of each other.
If one or more cells have a much higher voltage difference, consider the battery damaged.
15. Let the battery rest for a few hours.
16. Check the voltage of the battery.
It should comfortably sit above 12.8V (25.6V), like 13.2V (26.4V) or higher. And the cell voltages should still be within 0.1V of each other.
17. Let the battery rest for 24 hours.
18. Measure the voltages again.
If the battery voltage is below 12.8V (25.6V) or there is a noticeable cell imbalance, consider the battery damaged beyond recovery.

6.1.6. Battery is close to end-of-cycle life or has been misused

As a battery ages, its capacity will reduce, and eventually, one or more battery cells will become faulty. Battery age is related to how many charge/discharge cycles the battery has been through.

The battery can also have a reduced capacity or faulty cells if the battery has been misused, for example, if the battery has been discharged too deeply.

To determine what could have caused a battery issue, start by checking the battery history by looking at the history of a battery monitor or a Lynx Smart BMS.

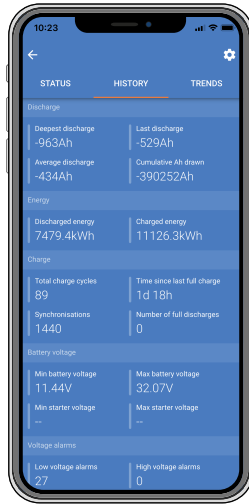

VictronConnect battery history

To check if the battery is close to its cycle life:

- Find out how many charge/discharge cycles the battery has been subjected to. Battery lifetime is related to the number of cycles.
- How deep has the battery been discharged on average? The battery will last fewer deep discharge cycles than shallow discharge cycles.
- For more info on the life cycle see chapter [Technical data \[33\]](#).

To check if the battery has been misused:

- Is the BMS connected and functional? Not using the battery with a Victron Energy-approved BMS voids the warranty.
- Is there mechanical damage to the battery, its terminals or the BMS cables? Mechanical damage voids the warranty.
- Has the battery been mounted upright? The battery can only be used in an upright position.
- Check the Allowed to charge minimum temperature setting in VictronConnect. Also, check if the battery temperature offset has not been set to an unrealistic value. Charging the battery below 5°C voids the warranty.
- Is the battery wet? The battery is not waterproof and is not suitable for outdoor use.
- Is there an indication that the battery has been totally discharged? Look at the battery monitor settings or VRM. Inspect the deepest discharge, minimum battery voltage and number of full discharges in the battery monitor. Total and very deep discharge voids the warranty.
- Is there an indication the battery has been charged with a too-high voltage? Check the maximum battery voltage and the high voltage alarms in the battery monitor.
- How many synchronisations were there? Each time the battery is fully charged, the battery monitor will synchronise. This can be used to check if the battery is receiving a regular full charge.
- What was the time since last full charge? The battery needs to be fully charged at least once a month.

6.2. BMS issues

6.2.1. The BMS frequently disables the battery charger

- A well-balanced battery does not disable the charger, even when the batteries are fully charged. But when the BMS frequently disables the charger, this is an indication of cell imbalance.

Check the cell voltages of all the batteries that are connected to the BMS using VictronConnect.

In case of moderate or large cell imbalance, it is expected behaviour that the BMS frequently disables the battery charger. This is the mechanism behind this behaviour:

As soon as one cell reaches 3.75V the BMS disables the charger. Whilst the charger is disabled the cell balancing process still continues, moving energy from the highest cell into adjacent cells. The highest cell voltage will drop, and once it has fallen below 3.6V the charger will be enabled again. This cycling typically takes between one and three minutes. The voltage of the highest cell will rise again quickly (this can be in a matter of seconds) after which, the charger will be disabled again, and so forth. This does not indicate a problem with the battery or the cells. It will continue with this behaviour until all cells are fully charged and balanced. This process might take several hours. It depends on the level of imbalance. In case of serious imbalance, this process can take up to 12 hours. Balancing will continue throughout this process and balancing even takes place when the charger is disabled. The continued enabling and disabling of the charger can appear strange but rest assured that there is no problem. The BMS is merely protecting the cells from overvoltage.

6.2.2. The BMS is prematurely turning chargers off

- This could be because of a cell imbalance. One cell in the battery has a cell voltage above 3.75V.

Check the cell voltages of all the batteries that are connected to the BMS.

6.2.3. The BMS is prematurely turning loads off

- This could be because of a cell imbalance.
- If a cell has a cell voltage below the "Allowed to Discharge" setting in the battery the BMS will turn the load off. The "Allowed to Discharge" level can be set between 2.6V and 2.8V. The default is 2.8V.
- Check the cell voltages of all the batteries that are connected to the BMS using the VictronConnect app. Also, check if all batteries have the same "Allowed to Discharge" settings.



Once the loads have been turned off due to low cell voltage, the cell voltage of all cells needs to be 3.2V or higher before the BMS will turn the loads back on.

6.2.4. The pre-alarm setting is missing in VictronConnect



Pre-alarm is only available if the battery supports it. The current battery models all support it, but older batteries do not have the hardware necessary for the pre-alarm feature.

6.2.5. The BMS is displaying an alarm while all cell voltages are within range

- A possible cause is a loose or damaged BMS cable or connector.

Check all BMS cables and their connections.

First rule out that the cell voltages and temperature of all connected batteries are in range. If they are all in range, then follow one of the following procedures.

Also consider that once there has been a cell under voltage alarm, the cell voltage of all cells needs to be increased to 3.2V before the battery clears the under voltage alarm.

A way to rule out if a fault is originating from a faulty BMS or from a faulty battery is to check the BMS using one of the following BMS test procedures:

Single battery and BMS check:

1. Disconnect both BMS cables from the BMS.
2. Connect a single BMS extension cable between both BMS cable connectors. The BMS cable should be connected in a loop, as in the below diagram. The loop tricks the BMS in thinking that there is a battery connected without any alarms.

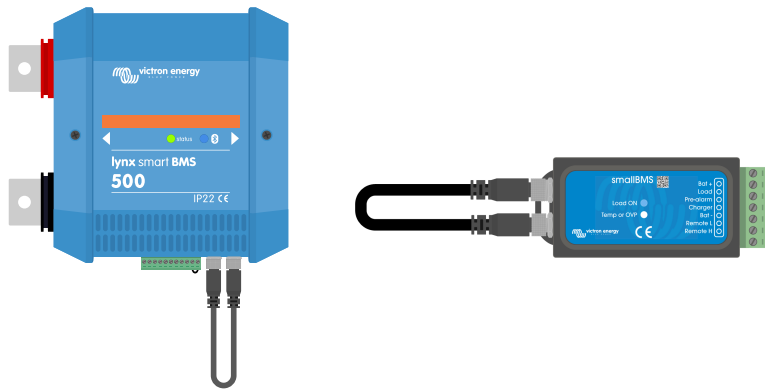

If the alarm is still active after the loop has been placed, the BMS is faulty.

If the BMS has cleared the alarm after the loop has been placed the battery is faulty and the BMS is not faulty.

Multiple batteries and BMS check:

1. Bypass one of the batteries by disconnecting both its BMS cables
2. Connect the BMS cables of the neighbouring batteries (or battery and BMS) to each other, effectively bypassing the battery.
3. Check if the BMS has cleared its alarm.

If the alarm has not been cleared, repeat this for the next battery.

If the alarm is still active after all batteries have been bypassed, the BMS is faulty.

If the BMS cleared its alarm when a particular battery was bypassed, that particular battery is faulty.

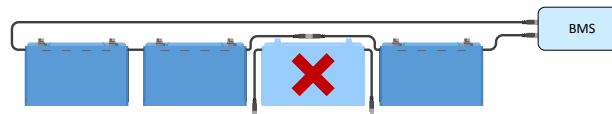

Eliminating a BMS error by bypassing a suspect battery

6.2.6. How to test if the BMS is functional

Disconnect one of the battery BMS cables and see if the BMS will go into alarm mode.

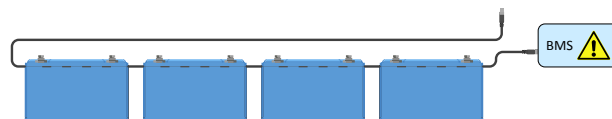

Check BMS functionality by deliberately disconnecting a BMS cable

6.3. VictronConnect issues

6.3.1. Cannot connect with VictronConnect to the battery

It is highly unlikely that the Bluetooth interface is faulty. Check these possible causes before seeking support:

1. Is the product a "Smart" product?
Non-Smart products do not support Bluetooth.
2. Is the battery voltage still high enough?
As a precaution, the Bluetooth module is turned off as soon as the battery terminal voltage drops below 8V or when one of the cells drops below 2V. The Bluetooth module will power up again once the battery is charged. When recharging the battery after a low voltage event, use the low voltage charge procedure described in the [Battery very low terminal voltage \[26\]](#) section.
3. Is there already another phone or tablet connected to the product?
Only one phone or tablet can be connected at any given time. Make sure no other devices are connected and try again.
4. Are you close enough to the product?
In open space, the maximum distance is about 20 meters.
5. Are you using the Windows version of the VictronConnect app?
The Windows version cannot use Bluetooth. Use an Android, iOS or macOS device instead.
6. Has Bluetooth been disabled in the battery product settings?
IMPORTANT: Disabling Bluetooth is an irreversible process. Once Bluetooth has been disabled, it can never be re-enabled.
7. Does the VictronConnect app have an issue?
Try to connect to another Victron Energy product, does this work? If that also does not work, there probably is an issue with the phone or tablet. Refer to the troubleshooting section of the [VictronConnect manual](#).

6.3.2. Pin code lost

If you have lost the PIN code, you will need to reset the PIN code to its default PIN code. This is done in the VictronConnect app.

1. Navigate to the device list of the VictronConnect app. Click on the option symbol  next to the product listing.
2. A new window will open, allowing you to reset the PIN code to its default: 000000.
3. Enter the battery's unique PUK code as printed on the product information sticker on the product.
4. More information and specific instructions can be found in the [VictronConnect manual](#).

6.3.3. Interrupted firmware update

- This is recoverable.
Just update the firmware again.

6.4. Warnings, alarms and errors

6.4.1. W-SL11: Under voltage warning (pre-alarm)

- The voltage of one or more cells is becoming too low and has dropped below the pre-alarm setting.



To remedy this warning, recharge the battery as soon as possible.

6.4.2. A-SL11: Under voltage alarm

- The voltage of one or more cells is below the configured Allow-To-Discharge cell voltage and discharging has been disabled



To remedy this warning, recharge the battery as soon as possible.

6.4.3. A-SL9 Over voltage alarm

- The voltage of one or more cells has become too high.



Immediately disable all chargers and contact the system installer to check that all chargers are properly controlled by the “charge disconnect” contact on the BMS. When properly controlled, a high voltage situation is not possible, as the BMS disconnects all chargers well before raising the high voltage alarm.

6.4.4. A-SL22: Under temperature alarm

- The battery has reached its low-temperature threshold and charging is disabled.



As soon as the temperature rises above the set threshold, the charging process will continue.

6.4.5. A-SL15: Over temperature alarm

- The battery has reached its high-temperature threshold and charging is disabled.



Provide adequate ventilation and make sure there is enough space around the battery. Reduce charging current and/or loads.

6.4.6. E-SL119: Settings data lost

- The settings data in the battery memory has been lost.



To remedy this, go to the settings page and reset settings to factory defaults.

If this error is not resolved after a settings reset, contact your Victron Energy dealer or distributor and ask for this issue to be escalated to Victron Energy, as this error should never happen. Please include the battery's serial number and firmware version.

6.4.7. E-SL24: Hardware failure

This error is generated in the following circumstances:

- One (or more) cells are very deeply discharged or defective.



Check the battery terminal voltage. If the battery terminal voltage is too low, refer to the [Battery very low terminal voltage \[26\]](#) chapter on what to do next.

- The internal circuit board has a hardware fault.



To resolve this, contact your Victron Energy dealer or distributor.



To resolve a "hardware failure" error, always first refer to the [Troubleshooting & support \[24\]](#) chapter of this manual before contacting your Victron Energy dealer or distributor. This is to rule out the first two possible causes of this error. Do not just assume that a hardware failure causes the error.

6.4.8. E-SL1: Balancer failure



Contact your dealer or distributor to resolve this situation.

6.4.9. E-SL2: Internal communication failure



Contact your dealer or distributor to resolve this situation.

6.4.10. E-SL9: Overlapped voltage error



Contact your dealer or distributor to resolve this situation.

6.4.11. E-SL10: Balancer update error



Contact your dealer or distributor to resolve this situation.

7. Technical data

Battery specification										
VOLTAGE AND CAPACITY										
Battery model LFP-Smart	12,8/50	12,8/60	12,8/100	12,8/160	12,8/200	12,8/300	12,8/330	25,6/100	25,6/200	25,6/200-a
Nominal voltage	12.8 V	12.8 V	12.8 V	12.8 V	12.8 V	12.8 V	12.8 V	25.6 V	25.6 V	25.6 V
Nominal capacity @ 25°C*	50Ah	60Ah	100Ah	160Ah	200Ah	300Ah	330Ah	100Ah	200Ah	200Ah
Nominal capacity @ 0°C*	40Ah	48Ah	80Ah	130Ah	160Ah	240Ah	260Ah	80Ah	160Ah	160Ah
Nominal capacity @ -20°C*	25Ah	30Ah	50Ah	80Ah	100Ah	150Ah	160Ah	50Ah	100Ah	100Ah
Nominal energy @ 25°C*	640 Wh	768 Wh	1280 Wh	2048 Wh	2560 Wh	3840 Wh	4220 Wh	2560 Wh	5120 Wh	5120 Wh
*Discharge current $\leq 1C$										

CYCLE LIFE (capacity $\geq 80\%$ of nominal)	
80% DoD	2500 cycles
70% DoD	3000 cycles
50% DoD	5000 cycles

DISCHARGE										
Maximum continuous discharge current	100A	120A	200A	320A	400A	600A	400A	200A	400A	400A
Recommended continuous discharge current	$\leq 50A$	$\leq 60A$	$\leq 100A$	$\leq 160A$	$\leq 200A$	$\leq 300A$	$\leq 300A$	$\leq 100A$	$\leq 200A$	$\leq 200A$
End of discharge voltage	11.2 V	11.2 V	11.2 V	11.2 V	11.2 V	11.2 V	11.2 V	22.4 V	22.4 V	22.4 V

OPERATING CONDITIONS	
Operating temperature	Discharge: -20°C to +50°C Charge: +5°C to +50°C
Storage temperature	-45°C to +70°C
Humidity (non-condensing)	Max. 95%
Protection class	IP 22

CHARGE										
Charge voltage	Between 14V/28V and 14.4V/28.8V (14.2V/28.4V recommended)									
Float voltage	13.5V/27V									
Maximum charge current	100A	120A	200A	320A	400A	600A	400A	200A	400A	400A
Recommended charge current	$\leq 30A$	$\leq 30A$	$\leq 50A$	$\leq 80A$	$\leq 100A$	$\leq 150A$	$\leq 150A$	$\leq 50A$	$\leq 100A$	$\leq 100A$

OTHER										
Max storage time @ 25°C*	1 year									
BMS connection	Male + female cable with M8 circular 3 pole connector, length 50cm									
Power connection (threaded inserts)	M8	M8	M8	M8	M8	M10	M10	M8	M8	M8
Dimensions (h x w x d) mm	199 x 188 x147	239 x 286 x 132	197 x 321 x 152	237 x 321 x 152	237 x 321 x 152	347 x 425 x 274	265 x 359 x 206	197 x 650 x 163	317 x 631 x 208	237 x 650 x 163
Weight	7kg	12kg	14kg	18kg	20kg	51kg	30kg	28kg	56kg	39kg
* When fully charged										

8. Appendix

8.1. Initial charge procedure without BMS

If, for a specific reason, the initial charge procedure needs to be performed without a BMS, this is the procedure for it. This procedure is for charging a single battery only. Please note that this is not something we recommend because this process is risky. This procedure must only be conducted under constant supervision. A constant VictronConnect session must be open to monitor the cell voltages at all times. Cell voltages can rise very quickly as they approach full charge, so the person supervising may need to intervene immediately to prevent a dangerous cell over-voltage scenario. A cell should never exceed 4V.



Charging without BMS is not the preferred method. It is risky, and a supervisor must be present at all times.

Recommended charger settings when performing an initial charge without a BMS

WARNING: Use these settings only during the initial charge process

Battery model	Max. charge current	Charge profile	Absorption voltage	Absorption time	Float voltage	Storage voltage
12.8V - 60Ah	20A	Lithium, fixed	13.8V	12h	14.2V	13.5V
12.8V - 100Ah	30A	Lithium, fixed	13.8V	12h	14.2V	13.5V
12.8V - 160Ah	50A	Lithium, fixed	13.8V	12h	14.2V	13.5V
12.8V - 200Ah	60A	Lithium, fixed	13.8V	12h	14.2V	13.5V
12.8V - 300Ah	100A	Lithium, fixed	13.8V	12h	14.2V	13.5V
25.6V - 200Ah	60A	Lithium, fixed	27.0V	12h	27.6V	27.0V

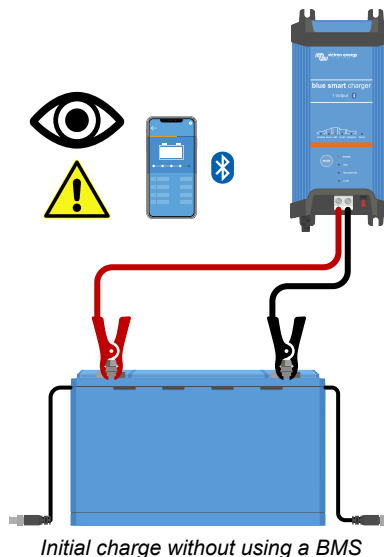

Charge procedure:

1. Use a battery charger suitable for lithium batteries, such as a Blue Smart charger.
2. Set the charger to the charge profile as indicated in the above table.
3. The supervisor connects with the VictronConnect app to the battery.
4. The supervisor monitors the individual cell voltages at all times.
5. The supervisor immediately interrupts the battery charge process should a battery cell voltage exceed 4 Volt.

6. The process is complete when all cell voltages are between 3.5V and 3.6V

8.2. Microcontroller power-cycle procedure



Carrying out this procedure may only be necessary when the battery has been discharged far too deeply. Before opening the battery, follow the instructions below carefully to determine if this procedure needs to be performed. Only use this procedure as a last resort after all other troubleshooting options have been exhausted!



This procedure involves opening the battery cover and temporarily disconnecting the positive terminal of the battery's internal circuit board. It should only be performed by Victron Energy dealers or distributors, technicians or professional users. If in doubt about performing this procedure, consult your Victron Energy dealer or distributor.

Introduction and when to use this procedure:

After a battery has been discharged too deeply with terminal voltages below 8V or 16V for 12V or 24V batteries respectively, a special slow charge procedure is required to recover the battery. This procedure is detailed in chapter [Battery very low terminal voltage \[26\]](#). Read that chapter carefully. After such an excessively deep discharge, it can happen that the microcontroller does not power up correctly. This chapter explains how to fix that by power cycling the microcontroller. Before opening the battery, first follow the instructions below carefully to make sure that it's actually necessary to perform this procedure at all.

Note that batteries will never be discharged to that level when installed and operated correctly. Make sure to understand why it happened, and amend the installation and/or the operation of the system accordingly.

Please be advised that the information in this chapter is intended to help installers or technically competent people to recover a battery from an excessively deep discharge state on site, where shipping the battery for repair would be impractical. If you are uncomfortable with conducting this procedure yourself, contact a Victron service or repair centre who will be happy to do it for you. Again, note that once cell voltages go below 2V damage has already set in. At best, the battery capacity will be noticeably reduced; in the worst case, the battery will need to be replaced.

How to recognise a stuck microcontroller:

First, make sure the system is within operational parameters:

- The battery temperature needs to be above the low-temperature cut-off (default is 5°C or 41°F).
- The battery needs to be charged, and the battery voltage above 13V (26V).
- The BMS cables between the battery and the BMS need to be connected and in good working condition.

Now, verify that the BMS still signals loads and chargers to disconnect. This table details how to do that for all available BMS's







The BMS is not allowing loads and chargers to operate when:	
SmallBMS	The blue "Load On" LED is off and the red "Temp or OVP" LED is on.
VE.Bus BMS	The red LED is on, the blue LED is off and the MultiPlus/Quattro LED is on.
Lynx Smart BMS	In VictronConnect (or a GX device IO tab), both the "Allow-to-charge" and the "Allow-to-discharge" parameters are disabled.
Smart BMS CL 12/100	The yellow and orange LEDs are off.
Smart BMS 12/200	The yellow and orange LEDs are off.
BMS 12/200	The "charge" and "output on" LEDs are off

Lastly, check that the battery is not visible in the VictronConnect device list. If the battery shows, the microcontroller is running normally and a power cycling is not required.

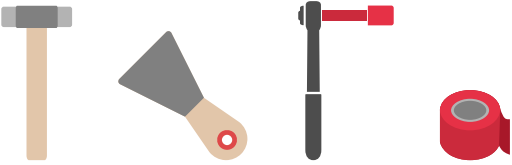
Micro-controller reset procedure:

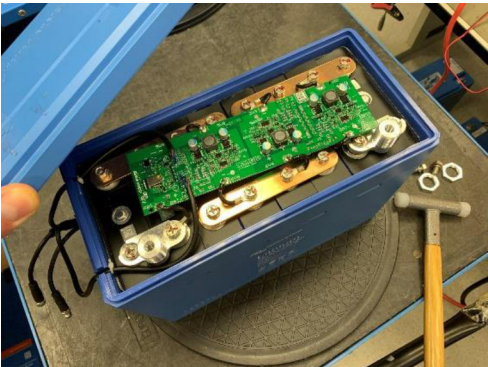

- Opening the battery will expose 12Vdc (or 24Vdc) voltages that can not be isolated.
- Always use insulated tools when working on batteries.
- Prevent short circuits between the battery terminals, the battery cell terminals, the cell busbars and/or the internal circuit board. There is no fuse protection.

<p>1</p>		<p>Tools needed:</p> <ul style="list-style-type: none"> •  Nylon or rubber hammer •  Scraper, chisel or flat screwdriver •  Insulated torque socket wrench M10 (electrical tape can be used to insulate the socket and part of the wrench) •  Electrical tape
<p>2</p>		<ul style="list-style-type: none"> • Remove the battery terminal wiring. • Remove the terminal hex nuts.
<p>3</p>		<ul style="list-style-type: none"> • Carefully loosen or break open the lid. This can be done with a scraper, flat screwdriver or chisel. When it creaks, it comes loose. Then continue a bit further until the lid is completely loose.
<p>4</p>		<ul style="list-style-type: none"> • Remove the top cover.

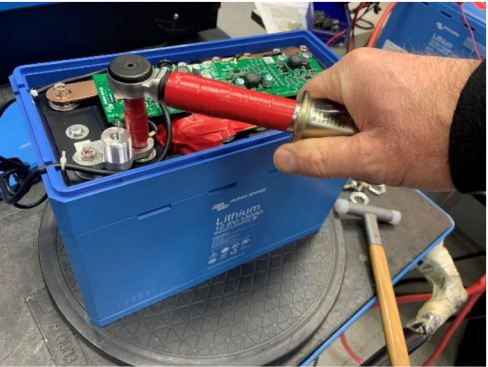
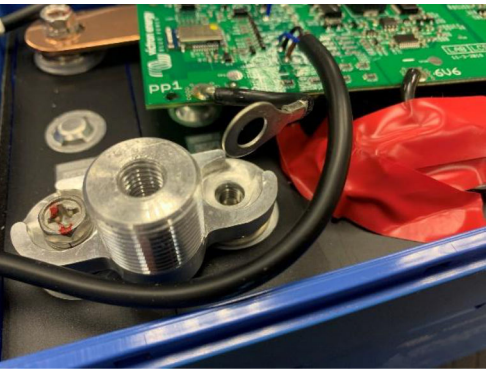
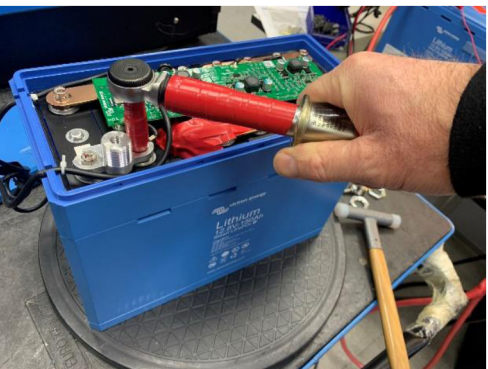
<p>5</p>		<ul style="list-style-type: none"> • Insulate the negative busbar terminal located next to the positive battery terminal. Do this by covering the busbar with electrical tape. See the red tape in the image on the left. <div data-bbox="880 385 1390 517" style="border: 1px solid #add8e6; padding: 5px; margin-top: 10px;"> <p>i The electrical tape is a precaution to prevent a possible short circuit between the positive battery terminal and the negative busbar.</p> </div>
<p>6</p>		<ul style="list-style-type: none"> • Loosen and remove the bolt that holds the positive circuit board wire cable lug.
<p>7</p>		<ul style="list-style-type: none"> • Leave the positive circuit board cable lug disconnected for a few seconds.
<p>8</p>		<ul style="list-style-type: none"> • Reinstall the positive circuit board cable lug and the bolt. • Fasten the bolt to 10Nm torque. • Remove the electrical tape.

9



- Put the cover back on the battery.
- Reinstall the terminal hex nuts.
- Reinstall the battery terminal wiring.

10

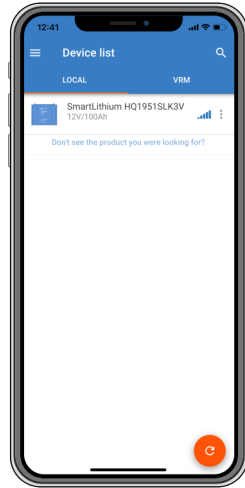

- Check if the BMS is now allowing loads and chargers to connect to the battery.
- Check to see if the battery appears in the device list of the VictronConnect app*.

If the BMS allows loads and chargers, the procedure was successful.

* Note that if the battery does not appear in the device list, this can be because Bluetooth has been disabled. See the [VictronConnect issues \[30\]](#) chapter for more information.

8.3. Cell balancing

Why is cell balancing needed

Though carefully selected during the production process, the cells in the battery are not 100% identical. Therefore, when cycled, some cells will be charged or discharged earlier than the other cells. These differences will increase over time if the cells are not regularly balanced.

When fully charged, the current through a lithium cell is almost zero. Lagging cells will not be charged further unless they receive "help" with this from cell-balancing electronics.

How does cell balancing work

The battery has built-in "active" and "passive" cell balancing. This ensures that all cells will be balanced. Each cell voltage is monitored, and if required, energy will be moved from the cell(s) with the highest voltage to the cells with a lower voltage. This process will continue until all cell voltages are within 0.01V of each other.

When does cell balancing take place

"Active" cell balancing begins when the first cell reaches 3.3V or less for severely unbalanced batteries.

"Passive" cell balancing starts when the cell voltages are 3.50V. This can happen only during the absorption charge stage, as during this stage, the charge voltage (14.2V or 28.4V) is high enough to for the cell voltages to also be sufficiently high to allow smaller cell differences to be corrected.

The cell balancing process is nearing completion when all cells have reached a voltage of 3.55V and the charge current has dropped below 1.5A. Balancing is complete when the charge current has dropped even further.

How to ensure that the battery remains balanced

A 2-hour fixed absorption period is recommended for lithium batteries so that there is enough time for cell balancing to take place. It is important to regularly fully charge the battery. This so the battery spends enough time in the absorption stage. A full charge once a month should be sufficient. However, there are some applications where the cells will become unbalanced quicker than usual. This is the case when the system is used more intensively or if the battery bank consists of multiple batteries in series. To ensure a well-balanced battery, a weekly full charge is required for:

- Systems with a battery bank that contains batteries that are connected in series.
- Systems that are charged/discharged every day or a few times per week.

- Systems that have high discharge currents.
- Systems that have short charge periods or low charge voltages.

It is not possible to speed up the cell-balancing process

Please note that a higher charge voltage will not speed up the cell balancing process. The cells are charged by current and not by voltage. Feeding current into a cell will cause the voltage to increase over time, but this is a fixed process. Applying more voltage will not speed this process up. In addition to this, the balancing speed is determined by the maximum current rating (1.8A) of the active and the passive balancing circuits.

How to monitor cell balancing status

Use the VictronConnect app to monitor the balance status of the battery. The app will indicate 4 balancing stages, being:

- **Unknown**
- **Balancing**
- **Balanced**
- **Imbalance**

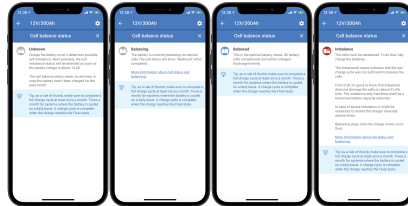

Cell balancing information. From left to right: unknown, balancing, balanced and imbalance.



For detailed information on these 4 stages, click the  information text located below the cell status listing, and a pop-up window will open up with an explanation of each stage.

The app also indicates the days since the last full battery charge. If the full charge was more than 30 days ago, it will indicate "unknown". This means that the battery has not received its recommended monthly charge.