



GX LTE 4G manual

Table of Contents

1. Introduction	1
1.1. General description	1
2. Features	2
2.1. Built-in GPS receiver	2
2.2. GX compatibility	2
2.3. SIM card	2
2.4. When to use a mobile router instead	2
2.5. Antennas and accessories	2
2.6. What's in the box?	2
3. Installation and configuration	3
3.1. Installation step-by-step	3
3.2. Configuration	4
4. Operation	6
4.1. SIM status	6
4.2. Status Bar	6
4.3. GPS	6
5. Troubleshooting	7
5.1. Troubleshooting guide	7
5.2. What to do if the GX LTE 4G is not staying connected?	7
6. Technical data	8
6.1. Technical data	8
7. Appendix	9
7.1. Accessory / Antennas	9
7.1.1. Outdoor 2G and 3G GSM Antenna	9
7.1.2. Outdoor 4G GSM Antenna	9
7.1.3. Active GPS Antenna	10
7.2. Notes regarding regional coverage	10
7.3. Dimensions	10
8. Warranty	11
8.1. Five year limited warranty	11

1. Introduction

1.1. General description

The GX LTE 4G is an accessory for [GX devices](#). It is a cellular modem that supports 2G, 3G and 4G technologies. It provides mobile internet for the system and a connection to the [Victron Remote Management \(VRM\) portal](#). See also the [GX LTE product page](#) on our website.

There are multiple models, refer to the table below to see which model best matches the available cellular network bands in your region.

Part number	Name	Region	Used module	Supported LTE bands
GSM100100400	GX LTE 4G-E	For EMEA (Europe, Middle-East, Africa), Korea, Thailand	SIMCom SIM7600E	1, 3, 5, 7, 8, 20, 38, 40, 41
GSM100200400	GX LTE 4G-A	For North America	SIMCom SIM7600A	2, 4, 12
GSM100300400	GX LTE 4G-SA	For Australia, New Zealand, South America	SIMCom SIM7600SA	1, 2, 3, 4, 5, 7, 8, 20, 28, 40, 66

For more details, please refer to the [SIM7600X Comparison Table](#).

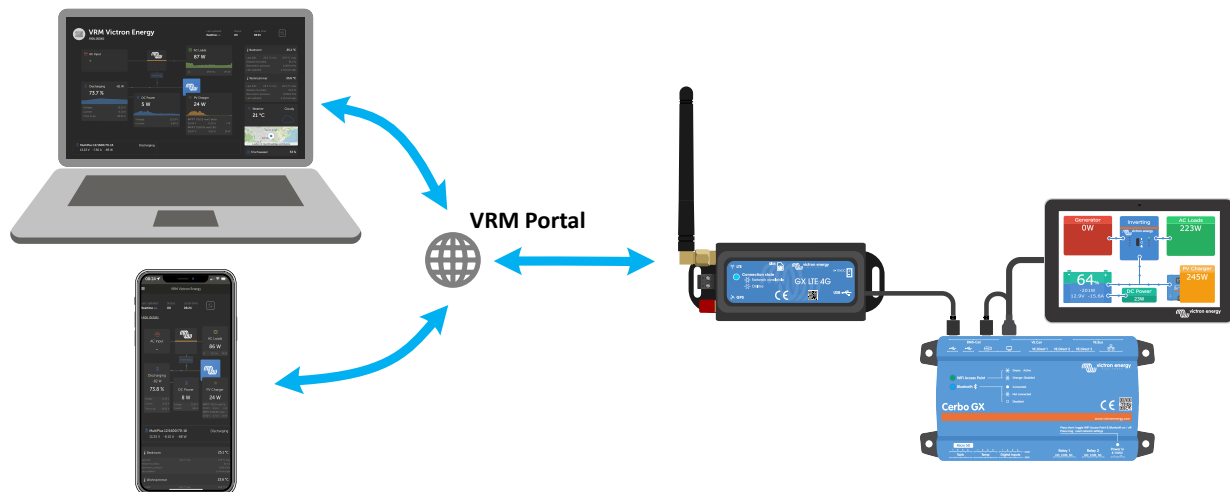

2. Features

2.1. Built-in GPS receiver

The GX LTE 4G includes a built-in GPS receiver. When the optional active GPS antenna is installed, the system can be tracked as well as geo-fenced on the VRM Portal.

The required accessory part number is GSM900200100 - Active GPS Antenna for GX GSM.

2.2. GX compatibility

The GX LTE 4G can be used with any of the GX devices and requires Venus OS v2.60 or newer to be installed on the GX device.

2.3. SIM card

It requires a SIM card of the [Mini-SIM format](#).

2.4. When to use a mobile router instead



The GX LTE 4G provides only an internet connection for the GX device. Sharing the internet with laptops, phones, or other devices is not possible.

For installations where more devices require internet, as is often the case on a yacht or RV, or where a reliable failover/backup solution is needed, consider installing a mobile router with this functionality instead.

A mobile router can share cellular data with multiple devices such as smartphones, tablets, laptops and other devices via its Ethernet port or WiFi and is able to switch to a previously configured WiFi connection in the event of an Ethernet connection failure or vice versa.

2.5. Antennas and accessories

A small indoor LTE antenna is included. Optionally, we also sell an outdoor LTE antenna, which increases the range:

- Part number GSM900100400 - Outdoor 4G GSM Antenna

2.6. What's in the box?

- GX LTE 4G (with integrated USB cable)
- GSM 2G/3G/4G mini rod antenna (for indoor use)
- DC power cable (with inline fuse and terminal block)

3. Installation and configuration

3.1. Installation step-by-step

Follow the steps below to install the GX LTE 4G:

1. Mount the device in a place that is not covered by metal objects. Consider using the optional outdoor antenna when installing the GX LTE 4G in a closed metal enclosure, car, or van to increase the range.
2. Mount the included antenna to the SMA connector labeled LTE.
3. An optional active GPS antenna is screwed onto the SMA connector labeled GPS.
4. Insert the SIM card. You will need to eject the SIM card tray with a pen or other pointy object. Be aware that the SIM card tray sits slightly recessed inside the unit. Be sure to push it all the way in.
5. Connect the GX LTE 4G to the GX device with the supplied USB cable. Use a USB hub if all USB sockets are already in use.
6. Connect the DC power supply (8 to 70 VDC). A 1.4 m cable with M10 cable lugs and a built-in Slow Blow fuse 3.15A 250V, 5x20mm is included. Pay attention to the correct polarity as labeled on the front sticker.
7. After power-up, the blue LED will be solid blue. Once it has registered on a network, the LED will start blinking slowly. Finally, when the internet connection is established, the LED will blink quickly.

3.2. Configuration

The GX LTE 4G is configured entirely via the connected GX device.

Setting a SIM-PIN helps reducing the risk of the SIM card being stolen and used. Use a mobile phone to set the SIM-PIN, and thereafter configure it on the GX device as follows:

1. When using a SIM card with its SIM-PIN security disabled, the system will work without further configuration.

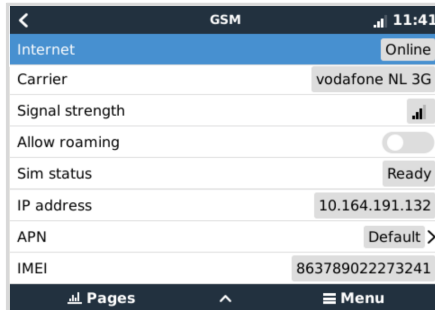

2. Setting a SIM-PIN helps reducing the risk of the SIM card being stolen and used. Use a mobile phone to set the SIM-PIN, and there after configure it on the GX device as follows:

Go to Settings → GSM modem → PIN.

3. Enter the same PIN that was previously set in the mobile phone or provided by the network operator.

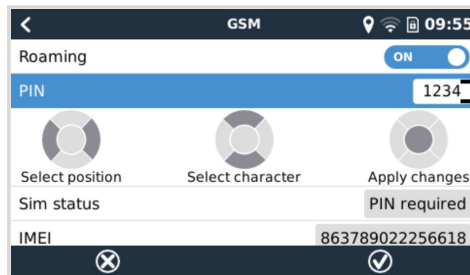

4. Go to Settings → GSM Modem → APN and set the APN name if necessary. Some mobile networks require manual configuration of an APN especially when roaming. Contact your network operator for details.

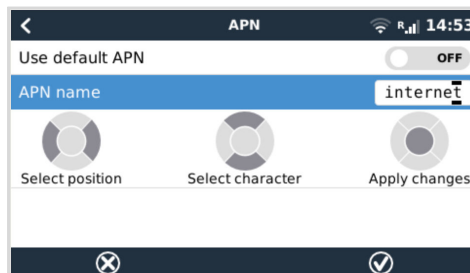

5. If you are installing the GX 4G LTE in an area where you can expect internet coverage to be occasionally disrupted, you should enable the “Reboot device when no contact” option in the GX device's VRM menu. This will automatically restart the GX device and power cycle the GX if it has failed to transmit data to VRM for the configured time.

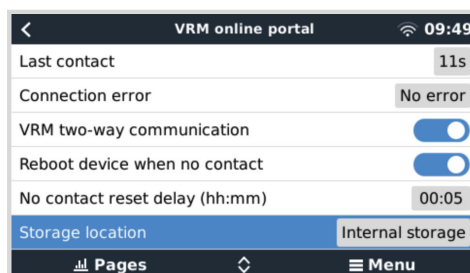



Note that if you are leaving internet service coverage areas (such as an RV on the move, or a boat leaving dock to go to sea), then it is recommend to disable this setting, so that your GX is not rebooting itself for no reason. Or set it, for example, to a two hour time-out and accept a reboot every two hours when underway.

Watch this video to learn how to connect via LAN, WiFi and the GX GSM which is the same as the GX LTE: [Connecting a Victron GX Device online and setting up a GX GSM](#)

4. Operation





4.1. SIM status

The SIM status is displayed on the GSM overview page on the GX device. The following table shows all possible states and their meaning:

Status	Description
Ready	SIM card is installed properly and registered to the network.
SIM not inserted	SIM card is missing or not inserted properly. SIM tray might hang out a little.
PIN required	SIM card requires a 4 digit PIN for unlock.
PUK required	SIM is locked due to wrong PIN inputs. 8 digit PUK is required to release the lock state.
SIM failure	SIM does not respond - might be broken.
SIM busy	SIM is in busy state.
SIM wrong	Type of SIM is not supported.

4.2. Status Bar

Cellular modem status can be checked at a glance by looking at the status bar.

Icon	Details
	Cellular modem is connected to network, but not to the internet (no data connection). Possibly on purpose, because an Ethernet or WiFi connection is available.
	Cellular modem is properly configured, the 4G/3G/Edge etc. icon reflects that the cellular modem internet connection is in use and what type of connection is applied.
	WiFi is available and its internet connection is in use. WiFi has priority over cellular connection.
	SIM-PIN code is required.
	Roaming, only informative. To use internet connection while roaming, it needs to be enabled in Settings → GSM modem → Allow roaming.

4.3. GPS

When the optional active GPS antenna is added, the position is sent to the VRM portal and also displayed in the GX device as follows:

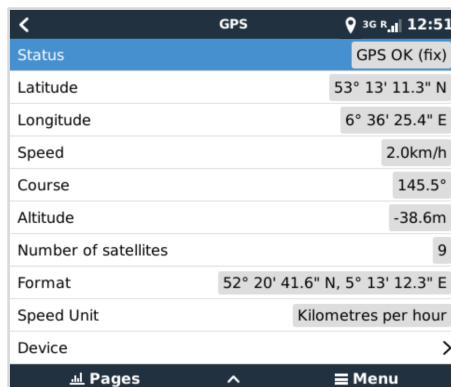

GPS	
Status	GPS OK (fix)
Latitude	53° 13' 11.3" N
Longitude	6° 36' 25.4" E
Speed	2.0km/h
Course	145.5°
Altitude	-38.6m
Number of satellites	9
Format	52° 20' 41.6" N, 5° 13' 12.3" E
Speed Unit	Kilometres per hour
Device	>

5. Troubleshooting

5.1. Troubleshooting guide

There are many reasons for a modem internet connection to not work. Carefully go through each step of this troubleshooting guide. Make sure to start at the first step. When asking for help, make sure to mention each step taken and the result.

Step	Element	Details
1	Power	Check that the blue LED is either lit continuous or blinking.
2	USB connection	The modem must be connected to USB, and visible in the Settings → GSM modem menu.
3	SIM card status	Check the SIM Status in the menu, it must show "Ready". It will show "SIM not inserted", or "PIN required", or "PUK required" and more related errors when there is a problem. Please refer to the SIM status list [6] for details.
4	Signal strength	1 bar minimum for VRM logging, 2 or 3 bars are necessary for a working remote console. An outdoor antenna typically increases received signal by 15 dB to 25 dB.
5	Carrier registration	Check that a name of a Cellular provider is visible in the "Carrier" field. If it is not, check signal strength and otherwise contact your SIM card provider and/or insert the SIM card in a phone to double check its operation and subscription status.
6	Internet connection	Verify that the Internet shows "Online". Reasons for the system to not go "Online" whilst properly registered on the Network are: 1) APN not configured, contact the network operator for details. 2) The network is a different one than the home network (ie. roaming), and the setting to permit Roaming is disabled. 3) Signal strength is strong enough to register on the network, but not to open the data connection to the internet.
7	Connection to VRM portal	Verify that the VRM Portal menu shows a recent last connection time. See Settings → VRM Portal. For more details, see the VRM Connection troubleshooting chapter of the GX Manual .



Note that Ethernet and WiFi connections have priority over the cellular connection. Even when the available Ethernet or WiFi connection does not have a good connection to the internet, there is no automatic detection in place which in such case switches over to the GX GSM. In more technical language: when the cellular data connection is active, it is configured with a high routing metric. This way, the Linux kernel prioritises Ethernet or Wifi when these are available.

5.2. What to do if the GX LTE 4G is not staying connected?

Enable the "Reboot device when no contact" configuration setting in the VRM menu of the GX device. That will reboot the GX (and with it the GX GSM) automatically if the internet connection is not available. See also the [configuration chapter \[4\]](#) for more details.

6. Technical data

6.1. Technical data

GX LTE 4G	GSM100100400 GSM100200400 GSM100300400
Supply voltage range	8 - 70VDC
Power draw	2.5W while 2G/3G/4G data transfer <1.0W in idle mode +0.4W if GPS is enabled
Operating temperature range	-40 +50°C (-40 - 120°F)
Power cable (included)	1.4m cable with inline fuse holder, terminal block and 10mm ring terminals
Inline fuse (included)	T3.15A250V
COMMUNICATION	
USB communication port	Fixed 1.0m cable with USB-A connector (connects to the GX device)
LTE antenna connector	Type SMA Female (optional 4G outdoor antenna GSM900100400)
GPS antenna connector	Type SMA Female (optional GPS antenna GSM900200100)
GNSS	GPS/Beidou/GLONASS/GALILEO/QZSS
SIM card	Regular Mini SIM (supports both 1.8V and 3V)
Data transmission (max. Download/Upload)	LTE Cat-1: 10 Mbps / 5 Mbps 3G (HSPA+): 42 Mbps / 5.76 Mbps 2G (EDGE): 236.8 Kbps / 236.8 Kbps 2G (GPRS): 85.6 Kbps / 85.6 Kbps
Status indicator	Blue LED
INSTALLATION & DIMENSIONS	
Dimensions (l x w x h)	106 × 42.5 × 22mm
Weight	0.08kg (0.177lbs)
Wire gauge (power cable)	0.5..1.5mm ² / AWG 28..16 or use supplied power cable
Recommended fuse size	500mA @ 12V / 250mA @ 24V / 100mA @ 48V or use supplied inline fuse
STANDARDS	
Safety	EN 60335-1 / EN 60335-2-29 / EN 62368-1
Emission / Immunity	ECE R10-5
QM	EN 9001:2015

7. Appendix

7.1. Accessory / Antennas

7.1.1. Outdoor 2G and 3G GSM Antenna



This antenna can be used with the GX LTE 4G, for 2G, 3G as well as 4G bands.

Part number	GSM900100100
Mounting option	Screw mount
Cable type	RG-316
Cable length	3.0 m
Connector	SMA Male straight
Frequencies	800/900/1800/1900/2100 MHz
Signal Gain	3 dBi

7.1.2. Outdoor 4G GSM Antenna



This antenna is optimised for 4G frequency bands and as such will have slightly better reception on the 4G network. It can be used with the GX LTE 4G for 2G, 3G and 4G bands.

If the 2G/3G variant does not provide sufficient signal quality in an installation, the solution is to contact a local GSM antenna provider. All the necessary information, including a link to the cellular modem (Simcom) used, can be found in this manual.

Part number	GSM900100400
Mounting option	Screw mount
Cable type	RG-316
Cable length	3.0 m
Connector	SMA Male straight
Frequencies	800/900/1800/1900/2100 MHz
Signal Gain	3 dBi

7.1.3. Active GPS Antenna



Part number	GSM900200100
Mounting option	Magnet
Cable type	RG-74
Cable length	3.0 m
Connector	SMA Male straight
Frequencies	1575.42 MHz
Impedance	50 Ω

7.2. Notes regarding regional coverage

A good reference to check frequencies is [4G world Coverage Map](#). Note that the page also contains 2G and 3G information, which is on its GSM World Coverage link on the top.

7.3. Dimensions

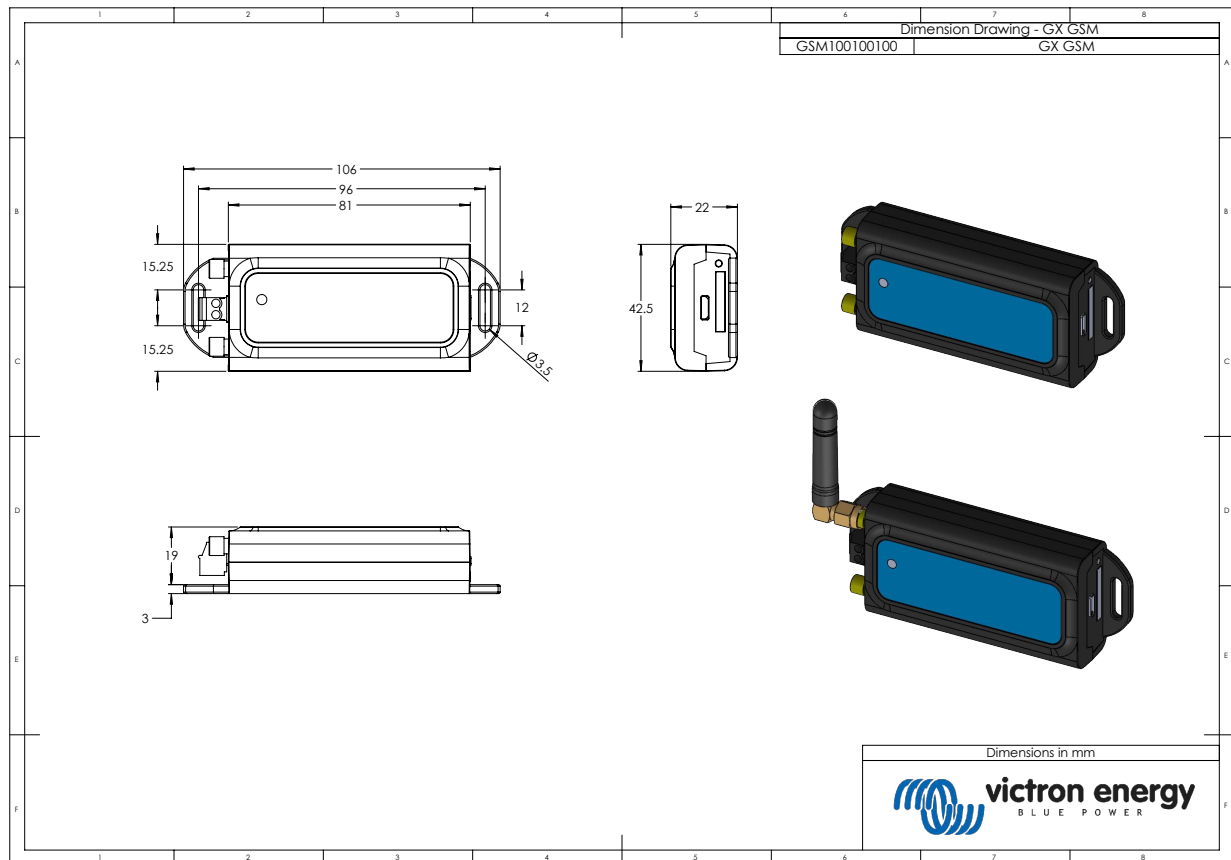

8. Warranty

8.1. Five year limited warranty

This limited warranty covers defects in materials and workmanship in this product and lasts for five years from the date of original purchase of this product.

The customer must return the product together with the receipt of purchase to the point of purchase.

This limited warranty does not cover damage, deterioration or malfunction resulting from alteration, modification, improper or unreasonable use or misuse, neglect, exposure to excess moisture, fire, improper packing, lightning, power surges, or other acts of nature.

This limited warranty does not cover damage, deterioration or malfunction resulting from repairs attempted by anyone unauthorized by Victron Energy to make such repairs.

Victron Energy is not liable for any consequential damages arising from the use of this product.

The maximum liability of Victron Energy under this limited warranty shall not exceed the actual purchase price of the product.