

Isolated SmartSolar MPPT RS

SmartSolar MPPT RS 450|100 & 450|200

Rev 16 - 04/2025

This manual is also available in [HTML5](#).

Table of Contents

1. Safety Instructions	1
1.1. Meaning of icons	2
2. General Description	3
2.1. Features	3
2.2. Interfacing and Communications	4
2.3. Setup options	4
3. Installation	5
3.1. Location of the MPPT	5
3.2. MPPT grounding, detection of PV array insulation faults & Earth fault alarm notification	7
3.3. Battery and battery lead requirements	8
3.4. Solar input wiring	9
3.5. Solar array configuration	10
3.5.1. MPPT RS example PV configuration	10
3.6. Cable connection sequence	12
3.7. Synchronised parallel operation	12
3.8. Energy Storage System (ESS)	12
3.9. User I/O	12
3.9.1. Remote on/off connector	12
3.9.2. Programmable relay	13
3.9.3. Voltage sense	13
3.9.4. Temperature sensor	13
3.9.5. Programmable analog/digital input ports	13
3.9.6. User I/O terminal diagram	14
3.9.7. User I/O functions	14
4. VictronConnect setup, configuration and operation	15
4.1. Setup	15
4.2. Overview page	16
4.3. Settings page	18
4.4. Product info	19
4.5. Battery	20
4.6. Solar	23
4.7. Relay	23
4.8. Display	25
5. Operation	26
5.1. Startup and shutdown procedure	26
5.1.1. Startup	26
5.1.2. Shutdown	26
5.2. Device display	26
5.3. Protections and automatic restarts	27
5.3.1. High battery voltage	27
5.3.2. High temperature	27
5.4. Maintenance	27
6. Troubleshooting	28
6.1. Troubleshooting and support	28
6.2. The solar charger is unresponsive	28
6.3. Solar charger is off	28
6.3.1. PV voltage is too low	29
6.3.2. Disabled in the settings	30
6.3.3. Reverse PV polarity	30
6.3.4. Safety relays are closed.	30
6.3.5. PV input fuses blown	31
6.4. Solar charger externally controlled	32
6.5. Batteries are not being charged	33
6.5.1. Battery is full	33
6.5.2. Battery not connected	34
6.5.3. Battery settings too low	35
6.5.4. Reverse battery polarity	35

6.5.5. Reverse PV polarity	35
6.6. Batteries are undercharged	35
6.6.1. Insufficient solar	36
6.6.2. Too much DC load	36
6.6.3. Battery cable voltage drop	36
6.6.4. Wrong temperature compensation setting	37
6.7. Batteries are overcharged	37
6.7.1. Battery charge voltages too high	37
6.7.2. Battery unable to deal with equalization	37
6.7.3. Battery old or faulty	37
6.8. PV problems	38
6.8.1. PV yield less than expected	38
6.8.2. Full rated output not reached	39
6.8.3. Mixed PV panel types	39
6.8.4. MC4 connectors wrongly connected	39
6.8.5. PV connections burned or melted	39
6.8.6. Optimisers cannot be used	39
6.8.7. Ground current	39
6.8.8. PV voltage too high	40
6.9. Communication problems	40
6.9.1. VictronConnect app	40
6.9.2. Bluetooth	40
6.9.3. VE.Direct port	41
6.10. Error code overview	42
7. Technical Specifications	47
7.1. Compliance	48
8. Appendix	49
8.1. Appendix B : Block Diagram	50
8.2. Appendix C : Example system schematic and wiring diagram	51
8.3. Appendix D : Dimensions	52

1. Safety Instructions



ELECTRIC SHOCK HAZARD

Please read this manual carefully before the product is installed and put into use.

This product is designed and tested in accordance with international standards. The equipment should be used for the designated application only.

Refer to the specifications provided by the manufacturer of the battery to ensure that the battery is suitable for use with this product. The battery manufacturer's safety instructions should always be observed.

Protect the solar modules from incident light during installation, e.g. cover them.

Never touch uninsulated cable ends.

Use only insulated tools.

Connections must always be made in the sequence described in the installation section of this manual.

The installer of the product must provide a means for cable strain relief to prevent the transmission of stress to the connections.

In addition to this manual, the system operation or service manual must include a battery maintenance manual applicable to the type of batteries used. The battery must be placed in a well-ventilated area.



SELECTION OF WIRE CONDUCTORS

Use flexible multistranded copper cable for the battery and PV connections.

The maximum diameter of the individual strands is 0,4mm/0,125mm² (0.016 inch/AWG26).

A 25mm² cable, for example, should have at least 196 strands (class 5 or higher stranding according to VDE 0295, IEC 60228 and BS6360).

An AWG2 gauge cable should have at least 259/26 stranding (259 strands of AWG26)

Maximum operating temperature: $\geq 90^{\circ}\text{C}$

Example of suitable cable: class 5 "Tri-rated" cable (it has three approvals: American (UL), Canadian (CSA) and British (BS)).

In case of thicker strands the contact area will be too small and the resulting high contact resistance will cause severe overheating, eventually resulting in fire.



RISK OF INJURY OR DEATH

The internals can carry a 400-500V DC voltage even when the product is off!

Input and/or output terminals may still be dangerously energized, even when the equipment is switched off. Always disconnect all power connections (e.g. the battery, DC solar isolator, etc) and wait at least 5 minutes before carrying out work on the product.

The product has no internal user-serviceable components. Do not remove the front plate or operate the product if any panels have been removed. All servicing must be undertaken by qualified personnel.

Please read the installation instructions in the installation manual before installing the equipment.

This is a Safety Class I product (supplied with a protective grounding terminal). The chassis must be grounded. Whenever it is likely that the grounding protection has been damaged, the product must be turned off and secured against unintended operation; please contact qualified service staff.

Non-isolated inverters shall be provided with installation instructions that require PV modules that have an IEC 61730 Class A rating.

If the maximum AC mains operating voltage is higher than the PV array maximum system voltage, then the instructions shall require PV modules that have a maximum system voltage rating based upon the AC mains voltage.

Environment and Access

Ensure that the equipment is used under the correct ambient conditions. Never operate the product in a wet or dusty environment. Never use the product where there is a risk of gas or dust explosions. Ensure there is adequate free space for ventilation above and below the product and check that the ventilation vents are not blocked.



Ensure that the unit is installed on a non-flammable surface and that surrounding construction materials are also made of non-flammable materials.

Installation of this product must be in a location that restricts access by persons (including children) with reduced physical, sensory or mental capabilities, or lack of experience and knowledge, unless they have been given supervision or instruction concerning use of the appliance by a person responsible for their safety.

The connections to live parts should be covered after installation.



Ensure that no flammable materials or objects will be stored close to the installation after it has been commissioned.

Enclosure Symbols

Symbol on the enclosure	
	Caution, risk of electric shock
	Refer to the operating instructions
IP21	IP21 Protected from touch by fingers and objects greater than 12 millimetres. Protected from condensation.
CE	European conformity
	Regulatory compliance mark for Australia & New Zealand

1.1. Meaning of icons

The icons printed on the product have the following meaning:

Icon	Meaning
	Caution, risk of electric shock
	Refer to the operating instructions

2. General Description

The MPPT RS is a solar charge controller intended to operate with a PV voltage of between 65-450V and designed to charge a 48V battery bank.

2.1. Features

Ultra-fast Maximum Power Point Tracking (MPPT)

Especially in case of a clouded sky, when light intensity is changing continuously, a fast MPPT algorithm will improve energy harvest by up to 30% compared to PWM charge controllers and by up to 10% compared to slower MPPT controllers.

Advanced Maximum Power Point Detection in case of partial shading conditions

If partial shading occurs, two or more maximum power points may be present on the power-voltage curve. Conventional MPPTs tend to lock to a local MPP, which may not be the optimum MPP. The innovative SmartSolar algorithm will always maximize energy harvest by locking to the optimum MPP.

Outstanding conversion efficiency

Maximum efficiency of 96%. Full output current up to 40°C (104°F).

Flexible charge algorithm

Fully programmable charge algorithm, and eight preprogrammed battery presets.

Extensive electronic protection

Over-temperature protection and power derating when temperature is high.

Isolated PV connections for additional safety

Full galvanic isolation between PV and battery connections provide additional overall system safety.

Optional external voltage and temperature sensor

Wired connections are available for battery voltage and temperature sensing. The Solar Charger uses these measurements to optimize its charge parameters. The accuracy of the data it transmits will improve battery charging efficiency, and prolong battery life. The Smart Battery Sense and other VE.Smart networking features are not currently supported.

2.2. Interfacing and Communications

VE.Direct port and two VE.Can ports

Either communications port type can be used for a wired data connection to a GX device (e.g. Cerbo GX, Color Control GX) PC or other devices. Note that only one port can be used at a time.

Device Display

A 4 line LCD back-lit display shows operational information including battery levels, solar yield, and system icons.

User I/O connector:

- Aux 1, 2 input
- Programmable relay
- Battery voltage sense (Vsense)
- Battery temperature sense (Tsense)
- Remote H & Remote L - Configurable

Bluetooth Smart built-in

The wireless solution to set-up, monitor and update the controller using Apple and Android smartphones, tablets or other compatible devices.

Configuring and monitoring with VictronConnect

Configure with the VictronConnect app. Available for iOS, Android devices, as well as macOS and Windows computers. A VE.Direct to USB accessory is required for Windows systems; enter VictronConnect in the search box on our website and see the VictronConnect download page for details.



2.3. Setup options

Adaptive three step charging

The Charge Controller is configured for a three step charging process: Bulk – Absorption – Float.

A regular equalization charge can also be programmed.

Bulk- During this stage the controller delivers as much charge current as possible to rapidly recharge the batteries.

Absorption - When the battery voltage reaches the absorption voltage setting, the controller switches to constant voltage mode. When only shallow discharges occur the absorption time is kept short in order to prevent overcharging of the battery. After a deep discharge the absorption time is automatically increased to make sure that the battery is completely recharged.

Additionally, the absorption period is also ended when the charge current decreases to less than 2A.

Float - During this stage, float voltage is applied to the battery to maintain a fully charged state.

Optional external voltage and temperature sensor

Wired connections are available for battery voltage and temperature sensing. The Solar Charger uses these measurements to optimize its charge parameters. The accuracy of the data it transmits will improve battery charging efficiency, and prolong battery life.

The Smart Battery Sense and other VE.Smart networking features are not currently supported.

Remote on-off input

Remote L functions as 'allow to charge' in case lithium battery is selected and remote H functions as 'allow to discharge'. Use smallBMS for the RS with Victron lithium batteries.

Programmable relay

Can be programmed (with a smartphone) to open or close on an alarm, or other events.

3. Installation

3.1. Location of the MPPT



To ensure a trouble free operation of the SmartSolar MPPT RS, it must be used in locations that meet the following requirements:

- a) Avoid any contact with water. Do not expose the product to rain or moisture.
- b) Install the SmartSolar MPPT RS upright and vertical. Ensure 30cm clearance above and below it.
- c) The SmartSolar MPPT RS must be installed on a non-flammable surface and the construction materials surrounding the installation should also be non-flammable.
- d) Do not place the unit in direct sunlight. Ambient air temperature should be between -40°C and 60°C (humidity < 95% non-condensing).
- e) Do not install the SmartSolar MPPT RS in an environment where the air could be contaminated with particulate matter such as soot, dust or salt. For example conductive soot from the exhaust of a diesel generator could be drawn into the unit and cause short circuits inside it.
- f) Do not install the SmartSolar MPPT RS where flammable or corrosive gases or vapours could come near the installation.
- g) Do not obstruct the airflow around the SmartSolar MPPT RS.
- h) If the SmartSolar MPPT RS is installed in an area used for general storage, ensure that no flammable materials such a cardboard boxes are stored close to the installation. Ensure that the end user is aware of these requirements.

Figure 1. Thermal image of MPPT RS heat zones required for clearance.



This product contains potentially dangerous voltages. It should only be installed under the supervision of a suitable qualified installer with the appropriate training, and subject to local requirements. Please contact Victron Energy for further information or necessary training.



Excessively high ambient temperature will result in the following:

- Reduced service life.
- Reduced charging current.
- Reduced peak capacity, or shutdown of the MPPT.

Never position the appliance directly above lead-acid batteries. The MPPT RS is suitable for wall mounting. For mounting purposes, a hook and two holes are provided at the back of the casing. The device must be fitted vertically for optimal cooling.



For safety purposes, this product should be installed in a heat-resistant environment. You should prevent the presence of e.g. chemicals, synthetic components, curtains or other textiles, etc., in the immediate vicinity.



Try and keep the distance between the product and the battery to a minimum in order to minimise cable voltage losses

3.2. MPPT grounding, detection of PV array insulation faults & Earth fault alarm notification

The SmartSolar MPPT RS will test for sufficient resistive isolation between PV+ and GND, as well as PV- and GND. If the resistance falls below the threshold, the unit will report an error and send an error signal to the GX device (if connected) for audible and email notifications. Despite the error, the product will continue charging the battery.

If an audible alarm and/or email notification of this fault is required, then you must also connect a GX device (such as the Cerbo GX). Email notifications require an internet connection to the GX device and a properly configured VRM account.

The positive and negative conductors of the PV array must be isolated from ground.

Ground the frame of the PV array according to local regulations. Use the ground lug on the chassis to connect the unit to the common earth.

The grounding conductor from the chassis ground lug to the earth must have a cross-section at least equal to that of the PV array conductors.

When a PV resistance isolation fault is indicated, do not touch any metal parts. Contact a qualified technician immediately to inspect the system for faults.

The battery terminals are galvanically isolated from the PV array, ensuring that PV array voltages cannot transfer to the battery side of the system in the event of a fault.

3.3. Battery and battery lead requirements

In order to utilize the full capacity of the product, batteries with sufficient capacity and battery cables with sufficient cross section should be used. The use of undersized batteries or battery cables will lead to:

- Reduction in system efficiency.
- Unwanted system alarms or shutdowns.
- Permanent damage to system.

See table for MINIMUM battery and cable requirements.

Model		450/100	450/200
Battery capacity lead-acid		200 Ah	400 Ah
Battery capacity lithium		50 Ah	100 Ah
Recommended DC fuse		125 A - 150 A	250 A
Minimum cross section (mm ²) per + and - connection terminal	0 - 2 m	35 mm ²	70 mm ²
	2 - 5 m	70 mm ²	2 x 70 mm ²



Consult battery manufacture recommendations to ensure the batteries can take the total charge current of the system. Decision on battery sizing should be made in consultation with your system designer.



Use a torque wrench with insulated box spanner in order to avoid shorting the battery.

Maximum torque: 14 Nm

Avoid shorting the battery cables.

To access the battery terminals, undo the two screws at the bottom of the enclosure and remove the cover to expose the service compartment.

- The battery terminals for the MPPT RS 450/100 are located on the left-hand side of the wiring compartment.
- Remove the nut, spring washer, and flat washer before attaching the cable terminal lug.
- **Note:** The bottom nut is soldered to the PCB; do not attempt to loosen it.
- The battery terminals for the MPPT RS 450/200 are located on the left-hand side of the wiring compartment.
- There are two studs each for the positive and negative terminals, allowing for the doubling up of battery cables.
- Remove the nut, spring washer, and flat washer before attaching the cable terminal lug.

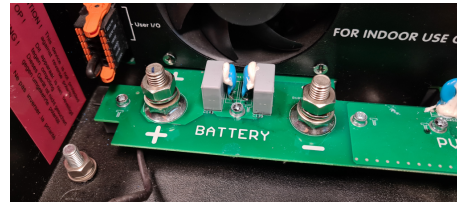

- It is important to place the terminal lug onto the stud first, followed by the flat washer, spring washer, and nut, in that order.
- Ensure that each nut is tightened to a maximum torque of 14 Nm.

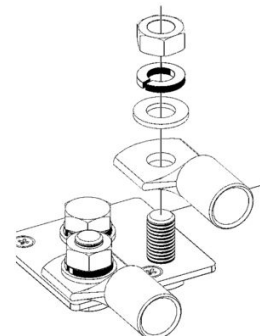

3.4. Solar input wiring

The SmartSolar MPPT RS is not fitted with a PV disconnect switch. An appropriately rated DC disconnection switch must be installed between the PV array and the SmartSolar MPPT RS.

Mount the PV disconnection switch in a readily accessible location.

 Ensure that the DC disconnection switch is properly rated for at least 450V DC. The disconnect switch **MUST** be rated for DC applications and be rated for at least the expected PV array short circuit current.

Do not use switches rated only for AC circuits.

The MPPT RS 450/100 and the MPPT RS 450/200 Solar charge controllers feature MC4 connectors located on the bottom of the unit. These connectors are pre-wired, so the bottom cover does not need to be removed to connect the PV cables.

The MPPT 450/100 is equipped with two pairs of MC4 connectors, one male and one female per tracker.

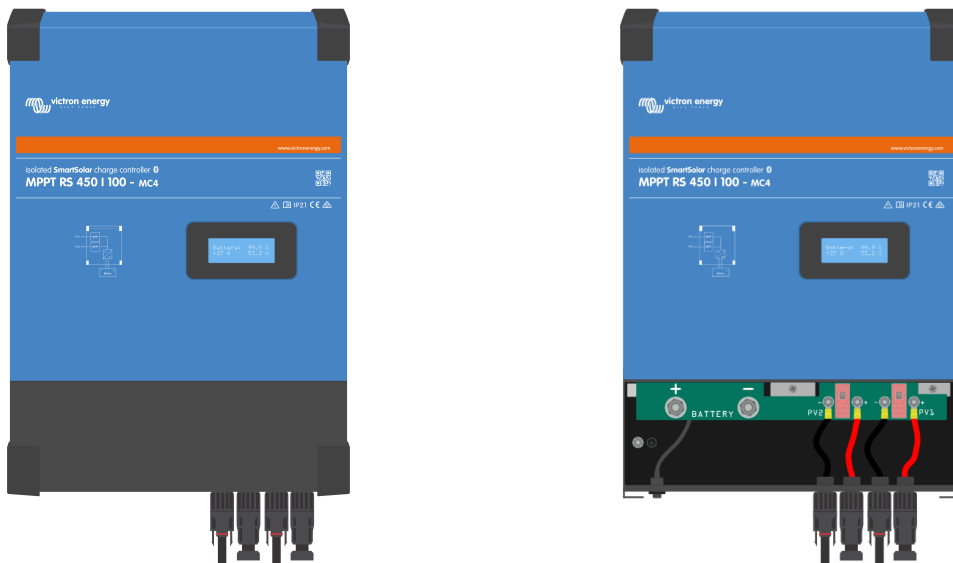

The MPPT 450/200 is equipped with four pairs of MC4 connectors, one male and one female per tracker.

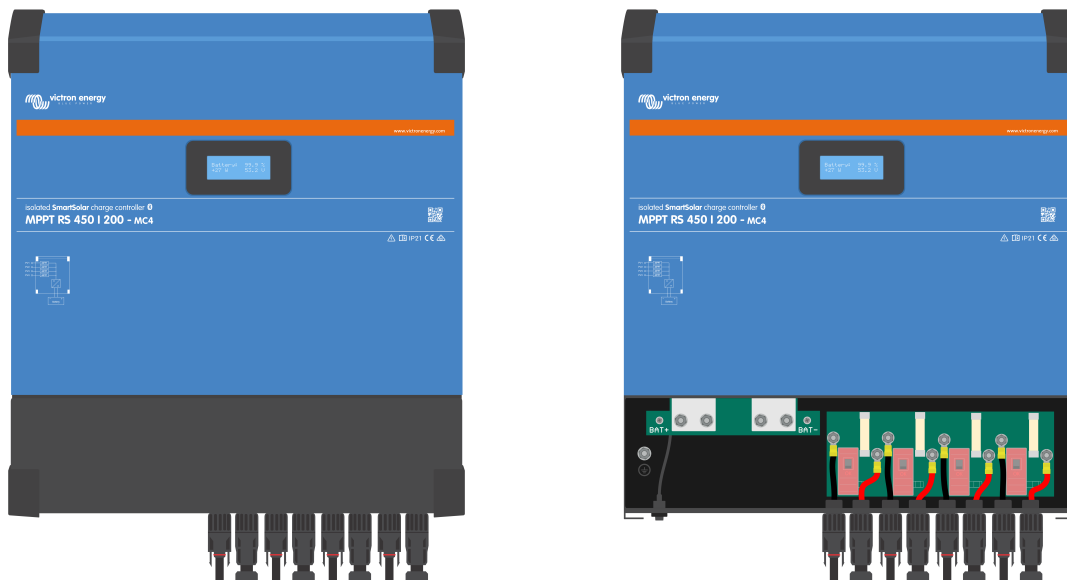

3.5. Solar array configuration

The MPPT RS must keep the individual tracker inputs isolated from each other. That means one solar PV array per input, do not attempt to connect the same array to multiple tracker inputs.



Always use genuine Staubli MC4 connectors for the PV connections to the SmartSolar MPPT RS. Connectors from other brands may not be fully compatible with the Staubli connectors on the SmartSolar MPPT RS.

The SmartSolar MPPT RS is built using Staubli MC4 connectors. There are many other brands available, but some manufacturing variations mean that they may make poor contact and cause excessive heat. There are also inferior brands on the market which will likely cause problems.



The maximum rated voltage of the solar charger is 450 V. A PV overvoltage event will damage the solar charger. This damage is not covered by warranty.

In case the PV array is located in colder climates the PV array can output more than its rated Voc. Use the [MPPT sizing calculator on the solar charger product page](#) to calculate this variable. As a rule of thumb, keep an additional 10% safety margin.

The maximum operational input current for each tracker is 16 A.

MPPT PV inputs are protected against reverse polarity, to a maximum short circuit current of 20 A for each tracker.

Connecting PV arrays with a higher short circuit current is possible, up to an absolute maximum of 30A, as long as connected with correct polarity. This outside of specification potential allows for system designers to connect larger arrays, and can be useful to understand in case a certain panel configuration results in a short circuit current just slightly above the maximum of the reverse polarity protection circuit.

Solar PV input cable insulation should be removed to allow 12 mm of exposed copper into the PV attachment point on the MPPT. It should not be possible to come into contact with any exposed copper wiring, the fit must be clean without any stray strands.



BEWARE that the product warranty will be void if a PV array with a short circuit current larger than 20 A array is connected in reverse polarity.



The MPPT RS must keep the individual tracker inputs isolated from each other. That means one solar PV array per input, do not attempt to connect the same array to multiple tracker inputs.

When the MPPT switches to float stage it reduces battery charge current by increasing the PV Power Point voltage.

The maximum open circuit voltage of the PV array must be less than 8 times the minimum battery voltage when at float.

For example, where a battery has a float voltage of 54.0 volts, the maximum open circuit voltage of the connected array cannot exceed 432 volts.

Where the array voltage exceeds this parameter the system will give a "Over-charge Protection" error and shut down.

To correct this, either increase the battery float voltage, or reduce PV voltage by removing PV panels from the string to bring the voltage back within specification.

3.5.1. MPPT RS example PV configuration



This is an example of an array configuration. The decision on the specific array configuration, sizing and design for your system should be made in consultation with your system designer.

Table 1. PV Array Example

Panel Type	Voc	Vmpp	Isc	Impp	# of panels	Max String Voltages	Power total per string
Victron 260W (60 cell)	36.75 V	30 V	9.30 A	8.66 A	# 1 - 11	# 1 - 404 V	2850 W
					#2 - 8	# 2 - 304V	2080 W

Figure 2. MPPT RS PV example diagram

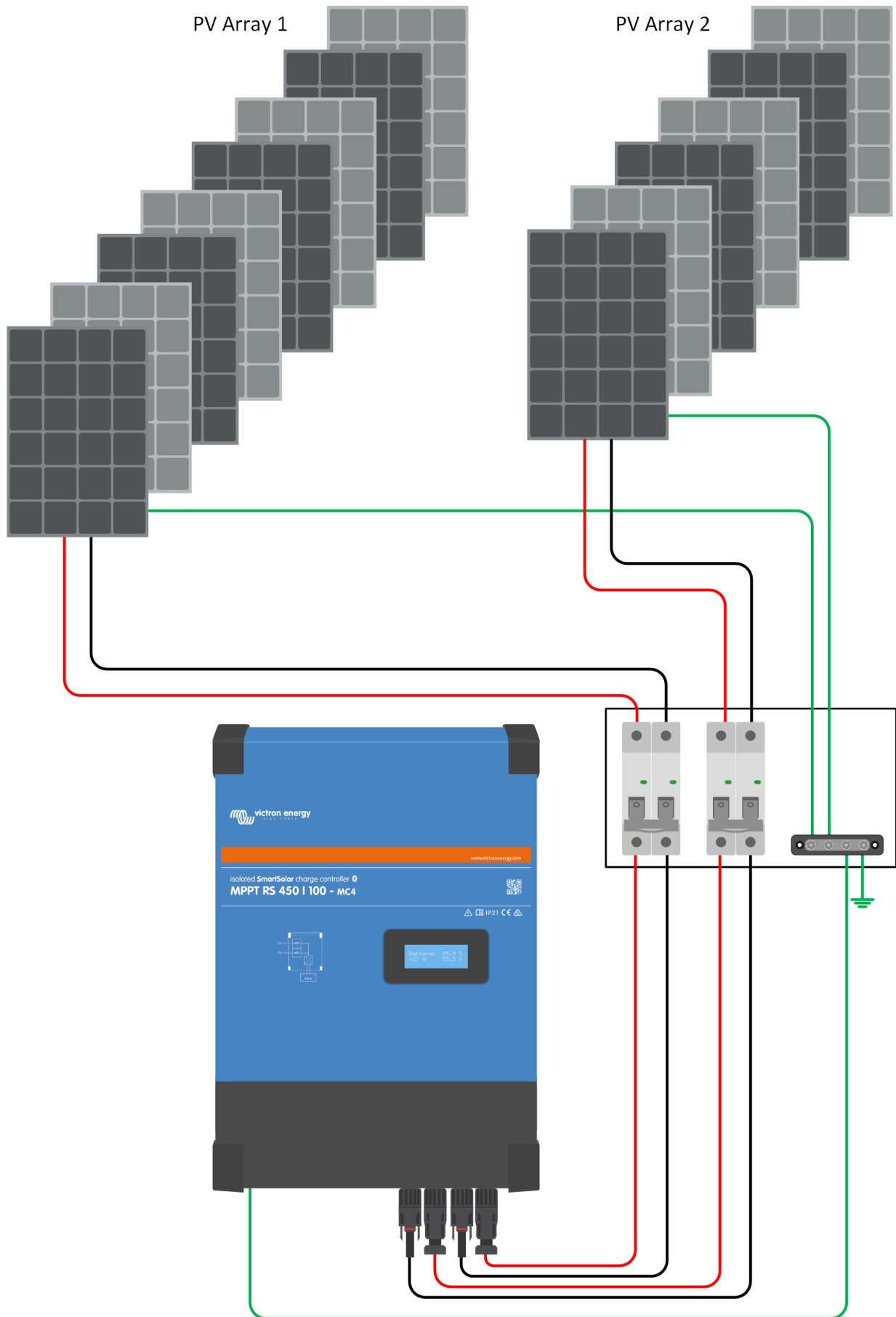

3.6. Cable connection sequence

First: Confirm correct battery polarity, connect the battery.

Second: if required, connect the remote on-off, and programmable relay, and communications cables

Third: Confirm correct PV polarity, and then connect the solar array (if incorrectly connected with reverse polarity, the PV voltage will drop, the controller will heat up but will not charge the the battery).

3.7. Synchronised parallel operation

Several charge controllers can be synchronised with the CAN interface. This is achieved by simply interconnecting the chargers with RJ45 UTP cables (bus terminators needed, see section 3.6).

The paralleled charge controllers must have identical settings (e.g. charge algorithm). The CAN communication ensures that the controllers will switch simultaneously from one charge state to another (from bulk charge to absorption for example). **Each unit will regulate its own output current**, depending on the output of each PV array and cable resistance.

In case of synchronized parallel operation, the network icon will blink every 3 seconds on all paralleled units.

The PV inputs should not be connected in parallel. Each charge controller must be connected to its own PV array.

3.8. Energy Storage System (ESS)

An Energy Storage System (ESS) is a specific type of power system that integrates a power grid connection with a Victron Inverter/Charger, [GX device](#) and battery system. It stores solar energy into your battery during the day for use later on when the sun stops shining.

Please refer to the following manual how to setup an ESS:

<https://www.victronenergy.com/live/ess:start>

3.9. User I/O

3.9.1. Remote on/off connector

The remote on/off connector has two terminals, the "Remote L" and the "Remote H" terminal.

The SmartSolar MPPT RS ships with the remote on/off connector terminals connected to each other via a wire link.

Note that for the remote connector to be operational, the main on/off switch on the solar charger needs to be switched to "on"

The remote on/off connector has two different operational modes:

On/off mode (default):

The default function of the remote on/off connector is to remotely switch the unit on or off.

- The unit will switch on if "Remote L" and the "Remote H" are connected to each other (via a remote switch, relay or the wire link).
- The unit will switch off if "Remote L" and the "Remote H" are not connected to each other and are free floating.
- The unit will switch on if "Remote H" is connected to battery positive (Vcc).
- The unit will switch on if "Remote L" is connected to battery negative (GND).

2-wire BMS mode:

This feature can be enabled via VictronConnect. Go to the Battery settings page, and then to "Remote mode".

Set the remote mode from "on/off" to "2-wire BMS".

In this mode, the "load", "load disconnect" or "allowed to discharge" signal and the "charger", "charger disconnect" or "allowed to charge" signals from a Victron lithium battery BMS are used to control the unit. They respectively turn the inverter off in case discharge is not allowed, and turn the solar charger off if charging is not allowed by the battery.

- Connect the BMS "load", "load disconnect" or "allowed to discharge" terminal to the Inverter RS Smart "Remote H" terminal.
- Connect the BMS "charger", "charge disconnect" or "allowed to charge" to the unit Inverter RS Smart "Remote L" terminal.

3.9.2. Programmable relay

Programmable relay which can be set for general alarm, DC under voltage or genset start/stop function. DC rating: 4A up to 35VDC and 1A up to 70VDC

3.9.3. Voltage sense

For compensating possible cable losses during charging, two sense wires can be connected directly to the battery or to the positive and negative distribution points. Use wire with a cross-section of 0,75mm².

During battery charging, the charger will compensate the voltage drop over the DC cables up to a maximum of 1 Volt (i.e. 1V over the positive connection and 1V over the negative connection). If the voltage drop threatens to become larger than 1V, the charging current is limited in such a way that the voltage drop remains limited to 1V.

3.9.4. Temperature sensor

For temperature-compensated charging, the temperature sensor (supplied with the unit) can be connected. The sensor is isolated and must be fitted to the negative terminal of the battery. The temperature sensor can also be used for low temperature cut-off when charging lithium batteries (configured in VictronConnect).

3.9.5. Programmable analog/digital input ports

The product is equipped with 2 analog/digital input ports, they are labelled AUX_IN1+ and AUX_IN2+ on the removable User I/O terminal block.

The digital inputs are 0-5v, and when a input is pulled to 0v it is registered as 'closed'

These ports can be configured in VictronConnect.

- **Unused:** the aux input has no function.
- **Safety switch:** the device is on when the aux input is active.

You can assign different functions to each aux input. In case the same function is assigned to both aux inputs then they will be treated as an AND function, so both will need to active for the device to recognise the input.

3.9.6. User I/O terminal diagram

Figure 3.

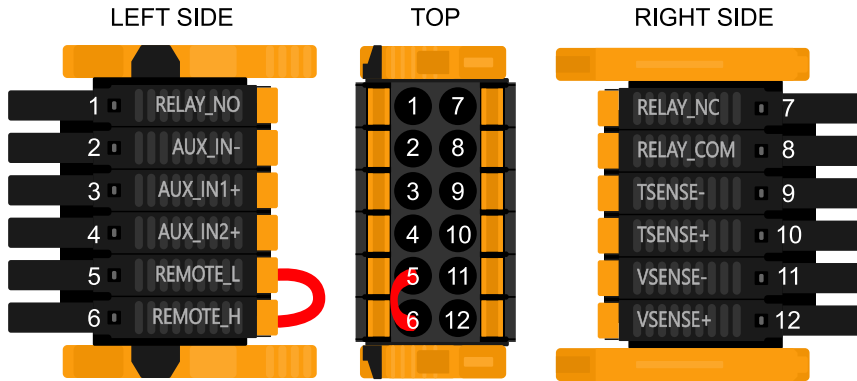

User I/O Connector is located on bottom left side of connection area, diagram shows 3 perspectives. Left Side - Top - Right Side

3.9.7. User I/O functions

Table 2. User I/O Functions - See Installation Section for more details.

Number	Connection	Description
1	Relay_NO	Programmable relay Normally Open connection
2	AUX_IN -	Common negative for programmable auxiliary inputs
3	AUX_IN1+	Programmable auxiliary input 1 positive connection
4	AUX_IN2+	Programmable auxiliary input 2 positive connection
5	REMOTE_L	Remote on/off connector Low
6	REMOTE_H	Remote on/off connector High
7	RELAY_NC	Programmable relay Normally Closed connection
8	RELAY_COM	Programmable relay common negative
9	TSENSE -	Temperature Sensor negative
10	TSENSE +	Temperature Sensor positive
11	VSENSE -	Voltage Sensor negative
12	VSENSE +	Voltage Sensor positive

4. VictronConnect setup, configuration and operation

4.1. Setup

The following steps are necessary to successfully connect the SmartSolar MPPT RS via Bluetooth and the VictronConnect app:

1. Make sure that Bluetooth is enabled on your SmartSolar MPPT RS. Bluetooth is enabled by default.



If Bluetooth has been disabled before then you'll need to connect to the SmartSolar MPPT RS using a VE.Direct to USB interface and the VictronConnect app to enable it again.

2. Download and install the VictronConnect app from the App Store or Google Play.
3. Open the VictronConnect app and scroll through the list of devices for the SmartSolar MPPT RS.
4. Tap on it to launch the pairing dialog. Enter the default pairing code which is either 000000 or is a unique PIN printed on the serial number sticker of the SmartSolar MPPT RS.

It is strongly advised, when prompted, to change the default PIN to a different one of your choice.

5. Once pairing is successful then the Overview page will be displayed.

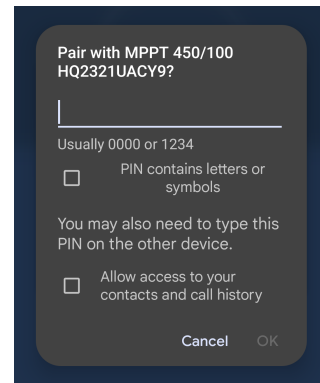

4.2. Overview page

The main overview page provides at-a-glance information of the SmartSolar MPPT RS. It is divided into three tabs:

- **Status:** Instant readout of the basic state of the MPPT charger.
- **History:** View up to the last 30 days of solar and battery data.
- **Trends:** Review current trend data.

Status tab:

- **Solar:** Total solar power of all trackers.
The details of each tracker are shown below the total, including Voltage, Power and Current.
- **Battery:** Shows the battery Voltage, charging current and state.
- **Relay:** Displays the the state of the relay contacts, Open or Closed.
If the relay mode is set to manual, then the Open or Closed state can also be controlled here.

More detailed state information:

In case the SmartSolar MPPT RS is not charging, an information tip will appear below the "State" field.

Tap this information field to bring up a popup window which will provide more information and some troubleshooting tips.

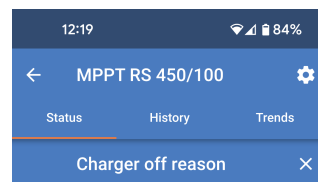
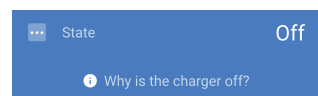

#OR1: Insufficient PV power
The charger is off because there is no or not enough PV power. This is the expected during night time and doesn't indicate any problem.

💡 During day time this might indicate a problem with your solar installation, contact your installer. Possible causes:

- Insufficient PV panels voltage.
- Loose connections, check that all the wires connection are tight.
- An external circuit breaker is tripped or a fuse is blown.

History tab:

- Up to 30 days of historic data is displayed.
- Bar graphs show the solar yield in kWh. The shaded areas highlight the time spend in the different charging stages.
- The "Solar panel" area records the total solar yield in kWh, maximum PV power and voltage.
- Maximum and minimum battery voltages are stored in the "Battery" section.
- If any errors were raised that day then they are shown with an orange circle.
- Lifetime total energy produced by the connected SmartSolar MPPT RS. The totals can be reset and so "Since reset" keeps the record yield since then.
- To export the graph as a .csv you can tap the triangular three dot icon at the top of the graph area. You'll then be presented with various methods by which to share the .csv (e.g. email, WhatsApp etc.).

 Tap the fragmented square icon in the top left of the graph area to rotate the graph. This will allow you to see a wide view of the graph with more days displayed at once.

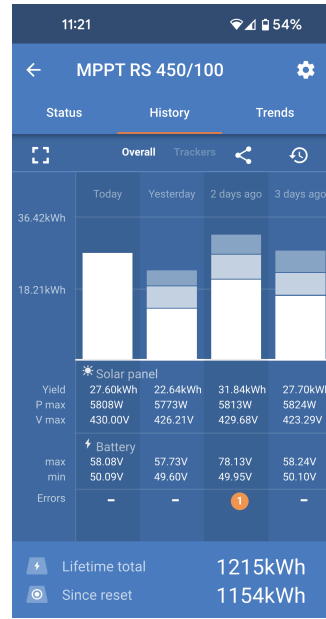

Trends tab:

- Two different data points can be selected using the drop down menus just above the graph.
- A graph will be rendered according to the selected parameters.

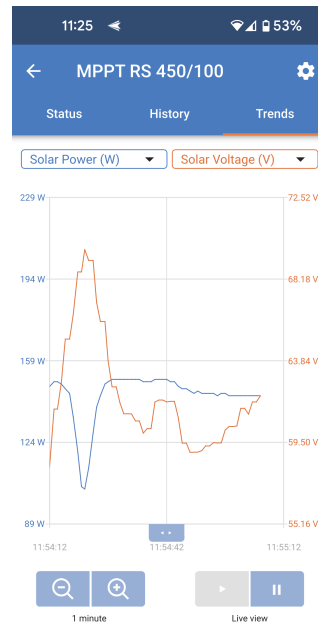

4.3. Settings page

The Settings menu is accessible by pressing the cog wheel from the top right of the Overview page.

The following menu options are available:

- **Battery:** Adjust the charging parameters for the battery.
- **Solar:** Switch PV optimisation on or off and set custom names for each PV tracker.
- **Relay:** Select from a variety of relay modes for the internal relay.
- **Display:** Choose how the LCD backlight behaves and preferred temperature unit.

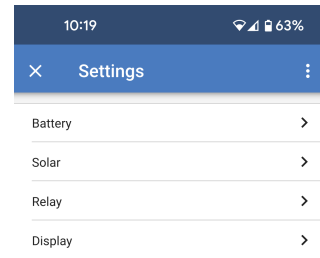

Tap the three vertical dots in the top right corner of the settings page to perform the following actions:

- **Import settings from file:** Import previously saved settings from a file in the settings library.
- **Save settings to file:** Save the current settings to a file which will be stored in the settings library. This file can be used as a backup to restore settings on this EV Charging Station NS or to easily apply the same settings to another one.
- **Share settings:** Share the settings file via email or other social apps which may be in use on the Android or iOS device for example.
- **Product info:** Displays the EV Charging Station NS model number and serial number. There is also a switch to enable or disable Bluetooth. See the Product info section for more information.
- **Reset to defaults:** Reset all settings to the factory defaults. This will mean that any customised settings will be lost and setup will need to be performed again or imported from a previously saved settings file.

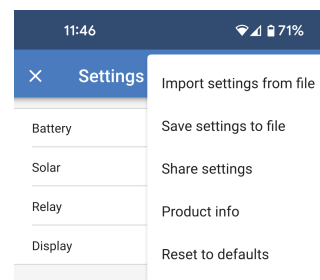

4.4. Product info

To get to the Product info page, tap the 3 vertical dots icon from the Settings page.

- **Product:** Shows the product name and the model number.
- **Serial number:** Shows the serial number of the SmartSolar MPPT RS.
- **NEMA2000 device instance:** Displays the network device instance number for this particular device.
- **Pin code:** The Pin code is hidden but it can be changed using the change button to the right.
- **Custom name:** Change the friendly name of the SmartSolar MPPT RS.
- **Firmware:** Displays the current firmware version running on the SmartSolar MPPT RS.
- **Bootloader:** The bootloader version.
- **Bluetooth:** Enable or disable the Bluetooth functionality of the SmartSolar MPPT RS.



Note that if you disable Bluetooth then connection to this device via Bluetooth will not longer be possible after you return to the Device list or exit the VictronConnect app. You'll need to connect using a VE.Direct to USB interface in order to enable Bluetooth again.

- **Instant readout via Bluetooth:** Enable this setting to display the most important data of the SmartSolar MPPT RS on the Device list page.
- **Instant readout details:** Tap "SHOW" to see the encryption data used for the Instant readout.

- **Lock product settings:** Use this option to lock the settings of the SmartSolar MPPT RS with a password. This will prevent others from changing critical settings without the password.
Tap "Add lock" to proceed to the "Lock product settings" page.
- **Product settings password:** Supply a password which will be used to unlock the product settings.

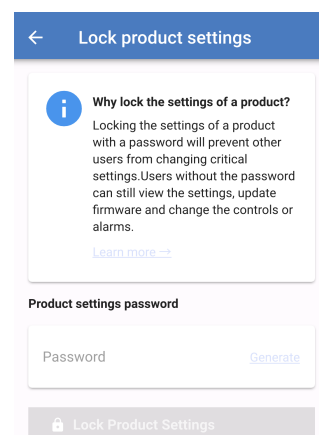
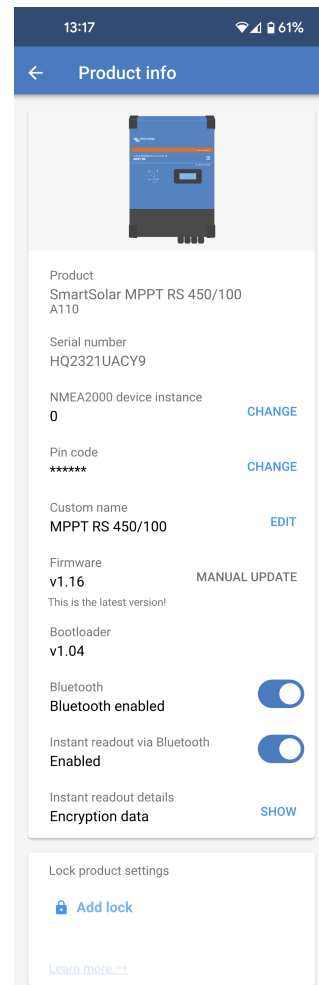

4.5. Battery

The Battery settings page allows adjustment of all of the parameters related to the battery which is connected to the SmartSolar MPPT RS. Some options will be greyed out if a fixed battery preset is selected. A "User defined" battery preset will allow all of the settings to be adjusted.

- **Battery voltage:** This option is always greyed out for the SmartSolar MPPT RS because it is only a 48V product.
- **Max charge current:** Adjust the maximum current that the SmartSolar MPPT RS will deliver to its battery terminals. By default, this is set to the maximum value. You may wish to reduce this if, for example, you have a smaller battery connected which cannot accept the maximum charge current.
- **Charger enabled:** Toggle this setting to enable or disable the charger. The batteries will not be charged if this setting is disabled.
- **Battery preset:** Use this to select the battery charge algorithm.
 - **Built-in preset:** Select one of the built-in presets (Normal, High and LiFePO4 2-wire BMS).
 - **User defined:** All parameters can be customized manually.
 - **Select preset:** Select a type from the VictronConnect app battery presets.
 - **Create preset:** Create a new custom battery preset in the VictronConnect app.
 - **Edit presets:** Edit an existing battery preset in the VictronConnect app.
- **Remote mode:** Configure what is connected to the REMOTE_L and REMOTE_H inputs on the user connector.
 - **Remote on/off:** A simple on/off switch to turn the SmartSolar MPPT RS on or off.
 - **2-wire BMS:** Use a wired BMS with allow-to-charge and allow-to-discharge signals like the SmallBMS. Note if 2-wire BMS is selected, then the unit will not start up until one is connected.
- **Expert mode:** This on/off toggle enables editing expert settings in case your equipment has special requirements. See "[Expert mode](#)" [22] section for details.

- **BMS controlled:** This item is only visible in case the unit is controlled remotely by a BMS. This is automatically enabled when the SmartSolar MPPT RS detects that it is connected to a system with a BMS. Click this field to change.

A confirmation box will pop up. Select "OK" to reset BMS control. The SmartSolar MPPT RS will no longer be controlled by a BMS. BMS control will be automatically enabled the next time it is connected to a system which has a BMS.

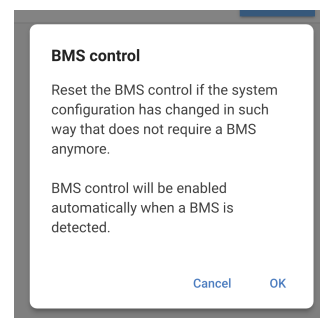
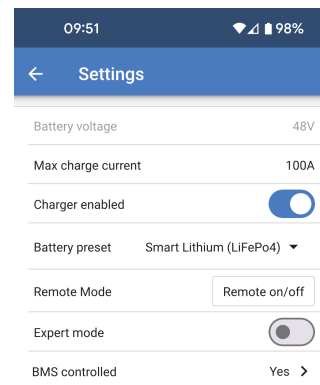

Charge voltages:

- **Absorbtion voltage:** Set the absorbtion voltage.
- **Float voltage:** Set the float voltage.
- **Equalization voltage:** Set the equalization voltage.

Equalization:

- **Automatic equalization:** Set-up the frequency of the auto equalize function. Available options are between 1 and 250 days.

Equalization is typically used to balance the cells in a lead battery, and also to prevent stratification of the electrolyte in flooded batteries. Whether (automatic) equalization is necessary, or not, depends on the type of batteries, and their usage. Consult your battery supplier for guidelines.

When the Automatic equalization cycle has initiated, the charger applies an equalization voltage to the battery as long as the current level stays below the equalization current percentage setting of the bulk current.

In the case of all VRLA batteries and some flooded batteries, automatic equalization ends when the voltage limit (maxV) has been reached, or after a period equal to (absorption time/8) - whichever comes first.

For all tubular plate batteries and also for the user-defined battery type, automatic equalization will end after a period equal to (absorption time/2).

For the lithium battery type, equalization is not available.

When an automatic equalization cycle is not completed in one day, it will not resume the next day. The next equalization session will take place according to the interval set in the 'Auto Equalization' option.

When an automatic equalization cycle is not completed in one day, it will not resume the next day. The next equalization session will take place according to the interval set in the 'Auto Equalization' option.

- **Manual equalization:** Tap "Start now" to begin equalization immediately. The duration is limited to 1 hour. This should only be initiated when absorbtion or float stages and when there is sufficient sunlight.

Voltage compensation:

- **Temperature compensation:** Many types of battery require a lower charge voltage in warm operating conditions, and a higher charge voltage in cold operating conditions.

The configured coefficient is in mV per degree Celsius for the whole battery bank, not per cell. The base temperature for the compensation is 25°C (77°F), as shown in the chart below.

With a temperature sensor installed to the User I/O connection block; the actual battery temperature will be used for compensation; throughout the day.

Battery limits:

- **Low temperature cut-off:** This setting can be used to disable charging at low temperatures as required by lithium batteries.

For lithium Iron Phosphate batteries this setting is preset at 5 degrees Celsius, for the other battery types it is disabled. When creating a user defined battery the cut-off temperature level can be adjusted manually.

Charge voltages	
Absorption voltage	57.60V
Float voltage	55.20V
Equalization voltage	62.00V
Equalization	
Automatic equalization	Disabled
Manual equalization	Start now
Voltage compensation	
Temperature compensation	-64.80mV/°C
Battery limits	
Low temperature cut-off	Disabled

When "Expert mode" is enabled, the following additional settings will become available:

Bulk:

- **Re-bulk voltage offset:** Set the voltage offset that will be used over the float voltage setting that will determine the threshold that the charge cycle will restart.

For example, a Re-bulk voltage offset of 0.4V and a float voltage setting of 54.0 V, the voltage threshold that will be used to restart the charge cycle will be 53.6 V. In other words, if the battery voltage drops below 53.6 V for one minute, the charge cycle will restart.

Absorption:

- **Absorption duration:** Select "Fixed" or "Adaptive". When you tap on the box to the right a detailed explanation for each option will pop up.
- **Maximum absorption time:** Set the absorption time limit. Only available when using a custom charge profile.
- **Tail current:** Set the current threshold that will be used to finish absorption phase before the maximum absorption time expires. When the battery current gets below the tail current for one minute, the absorption phase will end. This setting can be disabled by setting it to zero.

Equalization:

- **Equalization current percentage:** Set the percentage of the Max charge current setting that will be used when equalization is performed.
- **Automatic equalization:** This can be enabled and a periodic equalization cycle can be set to start.
- **Equalization stop mode:** Choose whether to stop equalization based on a certain voltage or by a fixed amount of time.
- **Maximum equalization duration:** Set the maximum time that the equalization phase will last.
- **Manual equalization:** Tap the "Start now" button to begin equalization immediately. The maximum duration of this event will be 1 hour.

Expert mode	<input checked="" type="checkbox"/>
Charge voltages	
Absorption voltage	57.60V
Float voltage	55.20V
Equalization voltage	62.00V
Bulk	
Re-bulk voltage offset	2.80V
Absorption	
Absorption duration	Adaptive
Maximum absorption time	8h 0m
Tail current	3.0A
Equalization	
Equalization current percentage	6%
Automatic equalization	Disabled
Equalization stop mode	Automatic, on voltage
Maximum equalization duration	1h 0m
Manual equalization	Start now

4.6. Solar

This page allows setting the Partial shading detection algorithm and giving each tracker a custom name.

PV optimisation:

- **Partial shading detection:** The default setting is enabled. It is recommended to leave this setting enabled. In some specific solar installations it may need to be disabled.

PV trackers names:

- Each tracker can be given a custom name. The column on the left will always display the tracker number and the column on the right will show the custom name if given.

The custom name will also be shown on the LCD on the front of the SmartSolar MPPT RS.

Tap on the row to set a custom name.

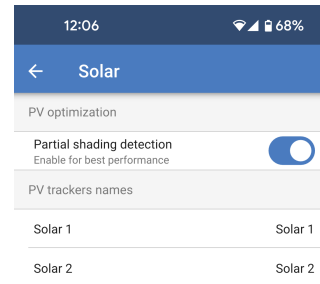

4.7. Relay

A programmable relay is available in the SmartSolar MPPT RS. The contacts are accessible via the User I/O terminals. See the [User I/O functions](#) table for the pinout.

- **Relay mode:** By default, the box is empty. Tap in the box to select or change the mode of operation for the relay.
- **Minimum closed time:** Defines the minimum amount of time that the relay will be closed after meeting a closure condition. This prevents quickly changing conditions from opening and closing the relay too often.

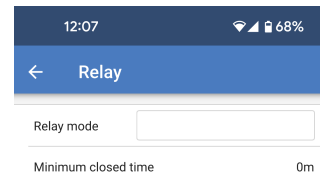

Relay mode

One of several relay modes can be selected from the list:

- **Relay always off:** The relay is always off and will not operate under any condition, there are no other configurable options. Use this option if you don't plan to use the relay.
- **Panel voltage high:** The option will switch the relay on and off based upon user defined high parameters.
 - **Panel high voltage:** The relay switches ON when this value is exceeded.
 - **Clear panel high voltage:** The relay switches OFF then the panel voltage falls below this value.
- **High temperature (dimming):** This option switches the relay ON when the charger output current is reduced due to high temperatures. Use this option to for example switch an external fan.
- **Battery voltage low:** This user defined option switches the relay on when the battery voltage falls too low, This can be used to disconnect loads to prevent further discharge when the battery is low.
 - **Battery low voltage relay:** Switches the relay ON when the battery voltage falls below the set value.
 - **Clear battery low voltage relay:** Switches the relay OFF when the battery voltage rises above the set value.
- **Equalization active:** This option switches the relay ON when the manual equalization mode is active.
- **Error state:** This option switches the relay ON when there is an error.
- **Defrost option (temp < -20°C):** This option switches the relay ON when the Charger temperature falls below -20 degrees Centigrade.
- **Battery voltage high:** This user defined option switches the relay ON when the battery voltage exceeds a set value. This option could be used to switch a load on when the battery goes above a certain voltage.
 - **Battery high voltage relay:** Switches the relay ON when the battery voltage exceeds this level.
 - **Clear battery high voltage relay:** Switches the relay OFF then the battery voltage falls below this value.
- **Float or storage state:** This option switches the relay ON when the charger is in the float or storage state. In float state the battery could be considered full and so the a load such as a water heater could be switched on to use excess solar energy.
- **Day detection (panels irradiated):** This option switches the relay ON whilst the solar panels are providing energy. This can be used as a simple day or night detection, for example to switch outdoor lighting off or on using the NC contact of the relay.
- **Manual control:** Use this option to control the relay manually from the Settings - Relay page or from the Overview page.

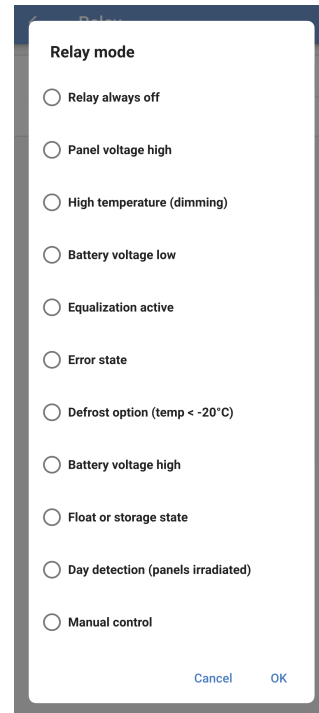

4.8. Display

These settings define the behaviour of the front panel LCD backlight and the temperature unit that it will display.

- **Display backlight:** Set up whether the front panel LCD backlight will be on or off.
 - **Always off:** The backlight will always be off.
The LCD may still be readable under strong ambient light but it will not emit light.
 - **Always on:** The LCD backlight is always on making it easy to read at a glance at any time.
 - **Automatic:** The LCD backlight is only on when the device is active.
- **Temperature unit:** Select which temperature unit will be used by the front panel LCD.
 - **Celcius:** Temperature is displayed in °C.
 - **Fahrenheit** Temperature is displayed in °F.



This setting only affects the temperature unit on the front panel LCD.

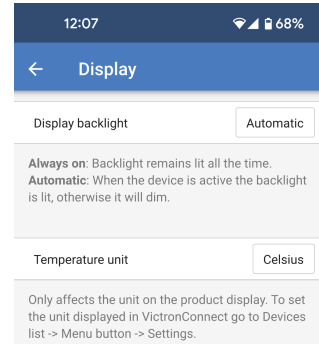

5. Operation

5.1. Startup and shutdown procedure

Note: This assumes that the correct installation procedures have been followed, and that the battery and PV polarity were tested and confirmed by the installer. These polarity tests are a critical part of the installation process but are not required during normal start-up or shut-down procedures.

5.1.1. Startup

Quickly connect the DC side load breaking fuse or isolator to provide DC power to the battery terminals of the unit.

Switch on PV array connection to the unit.

Switch on the unit using the on/off switch located on the bottom left hand underside of case, switch toward yourself for ON position.

When powering up, the screen will display the product details, firmware version, and if any start up errors are detected.

Operation will then commence (if correctly configured).

5.1.2. Shutdown

Switch off the unit using the on/off switch located on the bottom left hand underside of the case. Switch away from yourself for OFF position.

Switch off the PV array connection to the unit.

Quickly disconnect the DC side load breaking fuse or isolator providing DC power to the battery terminals.

Note: dangerous residual voltages may still exist inside the product and at the terminals after shutdown. Never open the product casing, or touch bare terminals.

5.2. Device display

The unit has an LCD screen that displays operational information. The screen cycles through the relevant displays every few seconds.

Startup Screen

When the units is first switched on it will display firmware, serial number and model details for severals while the unit performs self tests.

Battery:

Battery Power, Current, DC voltage, Temperature (*). Battery state (e.g. discharging, bulk, absorption, float, etc).

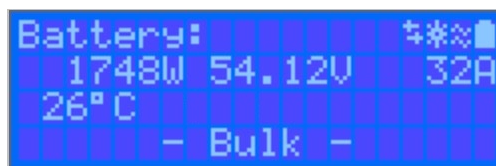

(*) These items are only visible if the data is available.

Solar 1

Solar Power, Voltage and Current, kWh daily and total Yield.

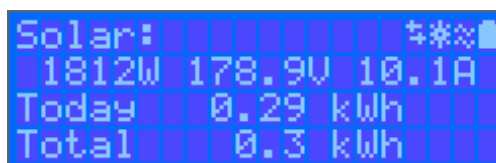

Additional MPPT Solar Trackers

Additional solar trackers will display the same values as above where available on additional screens.

Errors, Warnings and Alarms

The system will display code notifications as required. See troubleshooting section for additional information.

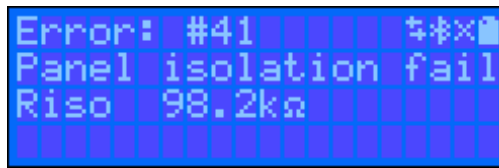

In the top right of the display are other system information icons.

	Communicating on any interface (e.g., Bluetooth, VE.Can, etc.)
	Bluetooth Enabled, Icon colour changes when connected
	MPPT Active
	(Blinking) Error or Warning
	Battery, fill corresponds with voltage, blinks when empty

5.3. Protections and automatic restarts

5.3.1. High battery voltage

Reduce DC input voltage and/or check for a faulty battery- or solar-charger in the system. After shutting down due to a high battery voltage, the unit will first wait 30 seconds and then retry operation as soon as the battery voltage has dropped to acceptable level.

5.3.2. High temperature

A high ambient temperature or enduring high charge current may result in MPPT reducing output and eventually shutting down to over temperature. The MPPT will resume once the temperature falls to within specification.

5.4. Maintenance

The solar charger does not need regular maintenance. Unqualified users should not attempt to open the product casing.

6. Troubleshooting

6.1. Troubleshooting and support

For unexpected behaviour or suspected product faults, refer to this chapter.

Start by checking the common issues described here. If the problem persists, contact the point of purchase (Victron dealer or distributor) for technical support.

If you're unsure who to contact or if the point of purchase is unknown, refer to the [Victron Energy Support webpage](#).

6.2. The solar charger is unresponsive

The solar charger is unresponsive (inactive) if the display is not illuminated, there is no charging activity, and it is not communicating with the VictronConnect app via Bluetooth or the VE.Direct port.

If the unit is active, the display is active or can communicate with the VictronConnect app via Bluetooth or the VE.Direct port.

For the solar charger to be active, it must be powered either via the battery or the PV terminals (or both), and the unit must be switched on.

In case the solar charger is not active, follow these steps to try to remedy this situation:

- The solar charger does not have an on/off switch. It will activate as soon as one (or both) of the battery or PV terminals are powered.

The voltage of the battery or the PV terminals needs to be above the minimum voltage as specified in the technical specifications chapter.

For instructions on how to check the voltage, see the below "Battery and PV terminal voltage check" procedure.

Battery and PV terminal voltage check procedure:



WARNING – A dangerous voltage can be (or is) present on the solar charger electrical terminals; only perform this procedure if you are a trained electrical technician.

- Use a multimeter set to DC voltage mode.
- Measure the voltage between the positive and negative battery terminals.
- Measure the voltage between the positive and negative PV terminals.
- Confirm that the battery or the PV voltage is at least above the minimum voltage as specified in the technical specifications chapter.

If the battery and PV terminals do not have a sufficient voltage:

- Check the battery and PV supply cables.
- Check the fuses and circuit breakers.
- Check if all connections are tight.
- Is the battery voltage sufficiently high enough? If not, charge the battery with an auxiliary charger.
- Is the PV voltage sufficiently high enough? Is there a problem with the PV array, or is it night?

If the unit remains unresponsive after confirmation of a sufficient battery or PV voltage:

- Consider the solar charger to be faulty.

6.3. Solar charger is off

If the solar charger is off, the VictronConnect app will indicate this. and

To find out the reason why the solar charger is off, click on the "Why is the charger off?" text.

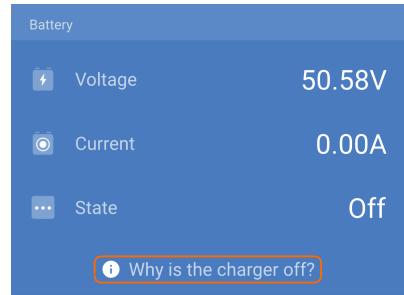

A pop-up window will appear with some of the explanations and possible remedies.

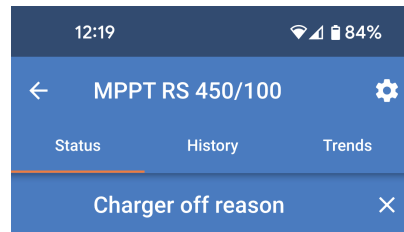

#OR1: Insufficient PV power

The charger is off because there is no or not enough PV power. This is the expected during night time and doesn't indicate any problem.



During day time this might indicate a problem with your solar installation, contact your installer. Possible causes:

- Insufficient PV panels voltage.
- Loose connections, check that all the wires connection are tight.
- An external circuit breaker is tripped or a fuse is blown.

Reasons why the solar charger is off:

- There is insufficient PV power.
- The settings being edited on an external display
- The charger is disabled in the settings.
- The charger is disabled by remote or BMS.
- Low lithium battery temperature.
- Safety relays are closed.
- PV input fuses blown.

6.3.1. PV voltage is too low

The solar charger will commence charging when the PV voltage is a minimum of 120V. Once charging has commenced, the PV voltage must remain higher than 65V for charging to continue.



Voltages above 50V are generally considered to be dangerous. Check your local electrical safety regulations as to the exact regulations. Dangerous voltages should only be handled by a qualified technician.

1. Use the VictronConnect app, a solar charger display or a GX device to check the battery voltage and PV voltage.
2. In case the above step is not possible, measure the battery and PV voltages at the solar charger terminals using a multimeter instead.
3. Compare both voltages. The PV voltage needs to be a minimum of 120V to start up, and also 80V to continue operation.

Causes of zero or low PV voltage:

- Not enough solar irradiance into the solar panels:

- Night.
- Cloud cover or bad weather.
- Shading.
- Dirty solar panels.
- Seasonal differences.
- Wrong orientation and/or inclination.
- Problems with a panel or panel wiring:
 - Mechanical or electrical issue with an individual panel (or multiple panels).
 - Wiring problems.
 - Blown fuses in the installation.
 - Open or faulty circuit breakers.
 - Splitters or combiners issues, or these are used in an incorrect way.
- PV array design issues:
 - Solar array wiring configuration mistake - not enough panels in a series string.
- Reverse PV polarity:
 - The positive and negative have been swapped when connected to the controller, read next paragraph: "Reverse PV polarity".

6.3.2. Disabled in the settings

The charger has been disabled in the settings.

Check the VictronConnect app settings - battery page to ensure that the charger has been enabled.



6.3.3. Reverse PV polarity

As long as the unit is installed within the published specifications, the PV input is protected internally against PV reverse polarity. In the case of reverse PV voltage, the solar charger will not indicate an error.

The only way to detect reverse PV voltage is by the following signs:

- The controller is not charging the batteries, the charge current is zero.
- The controller is getting hot.
- The PV voltage is zero, or close to zero.

If this is the case check for reverse polarity using a multimeter by ensuring that the positive PV cable is connected to the positive PV terminal, and the negative cable is connected to the negative terminal.



Measuring PV voltage at the PV terminals of a solar charger should only be performed by an electrical technician.

6.3.4. Safety relays are closed.

Safety relays, which are visible in the service compartment at the PV inputs, may have closed. This only happens if the SmartSolar MPPT RS has protected its self from a hazardous situation.

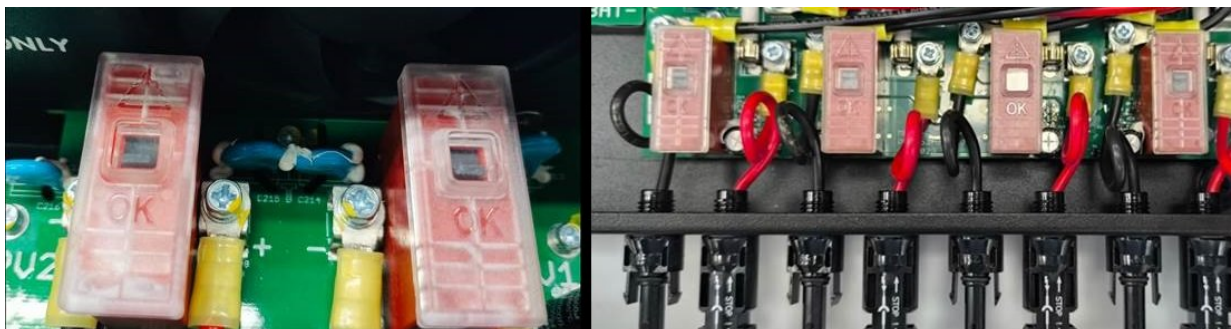

Under normal operating conditions, the small black flag on top of the relay should be in the "OK" position. Additionally, a green LED on the PCB will be lit, indicating that the safety circuits are actively monitoring for hazardous situations.

If the SmartSolar MPPT RS is powered on and active, but the green LED is not lit, it indicates that the safety circuits have been triggered. In this case, the flag on top of the relays will point toward the "!" symbol.

If the flag points to the position with a "!" symbol, it indicates that the relay is closed. When the relays are closed, the PV array is short-circuited to prevent PV power from entering the SmartSolar MPPT RS. As a result, the PV fuses or circuit breakers in the installation may also trip..

The red circle in image to the right shows the location of the green LED for the 450/100 model.

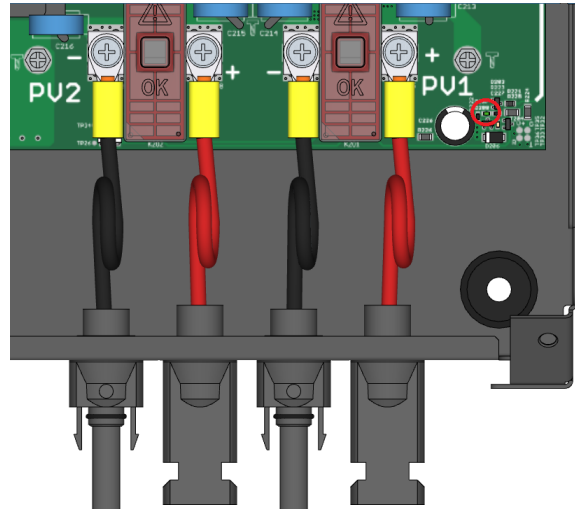

The red circle in image to the right shows the location of the green LED for the 450/200 model.

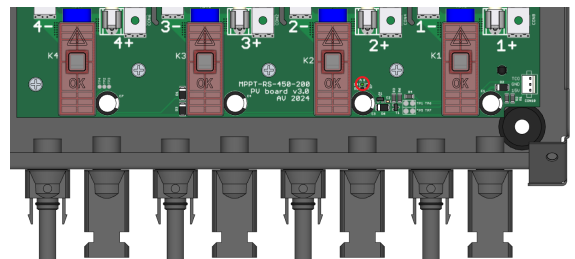

The fault cannot be cleared nor reset. The relays have closed to prevent further damage due to the internal fault.

The SmartSolar MPPT RS should be returned to the supplier.

 DO NOT ATTEMPT TO RESET THE SAFETY RELAYS. THE RELAYS HAVE CLOSED TO PROTECT FROM A HAZARDOUS SITUATION.

6.3.5. PV input fuses blown

If the fuses close to the PV input terminals are blown then the MPPT will be off.

The fuses will blow if a fault has occurred inside the SmartSolar MPPT RS. In this case you should return the unit to the supplier.

 Do not attempt to replace the fuses. The fuses will blow due to a fault being present inside the unit.



6.4. Solar charger externally controlled

The solar charger can be controlled by an external device. The external device can stop or reduce the charge current to the battery. This is not a fault but expected behaviour.

Managed batteries or an inverter/charger with an external control system like, for example, an ESS system, can control the solar charger via a GX device. The battery dictates if charging is allowed, and when charging is allowed, what charge voltage and currents are used. If external control is active this will be displayed in the VictronConnect app and also on the GX device.

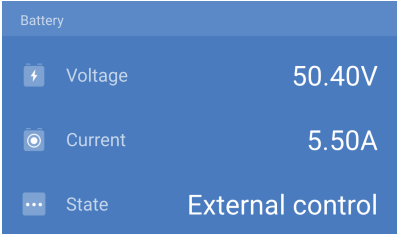
The VictronConnect app indicating that the charger is externally controlled.



Battery		
 Voltage		50.40V
 Current		5.50A
 State		External control

6.5. Batteries are not being charged

This chapter describes situations where the charger is active, but the batteries are not being charged.

The VictronConnect app indicates that the charger is active and the charge voltage is correct, but the charge current is zero, or close to zero.

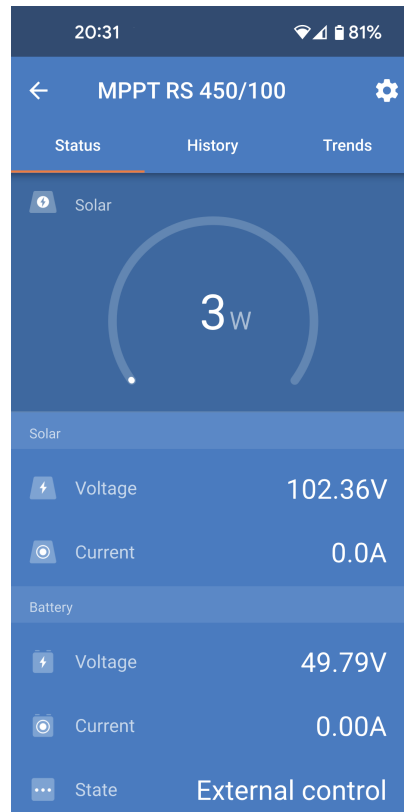

There are a number of reasons why this can happen, namely:

- The battery is full, and no more current is needed.
- The solar charging is not connected to the battery (cable, fuse or circuit breaker issues).
- Wrong configuration (voltage or current set too low).
- The charger is externally controlled (ESS or DVCC). See the [Solar charger externally controlled \[32\]](#) chapter.
- The battery temperature is too high and temperature-compensated charging is active or set incorrectly, see the [Wrong temperature compensation setting \[37\]](#) chapter.
- Reverse PV polarity.
- Reverse battery polarity.

6.5.1. Battery is full

Once the battery is full the solar charger will stop charging or will greatly reduce the charge current.

This is especially the case when at the same time the DC loads in the system are not consuming any power from the battery.

To find out what the state of charge (SoC) of the battery is, check the battery monitor (if present), or alternatively, check what charge stage the controller is in. Also, observe that the solar cycle is (briefly) progressing through these charge stages at the beginning of the daily charge cycle:

- Bulk stage: 0-80% SoC.
- Absorption stage 80-100% SoC.
- Float or storage stage: 100% SoC.

Be aware that it can also be possible that the solar charger thinks the battery is full, while in reality, the battery is not full. This can occur when the charge voltages have been set too low, causing the solar charger to prematurely switch to the absorption or float stage. For more information see the [Battery settings too low \[35\]](#) chapter.

6.5.2. Battery not connected

For the solar charger to be able to charge the battery it needs to be connected to the battery.

It might look like the battery is connected because the solar charger is able to operate without a battery connected and the VictronConnect app will show a battery voltage and a charge stage, but the charge current is zero or close to zero.

Possible causes of a disconnected battery:

- Loose or missing battery cables.
- Loose cable connections or badly crimped cable terminals.
- A blown (or missing) fuse in the battery supply cable.
- Open (or faulty) circuit breaker in the battery supply cable.
- Missing or incorrectly wired battery cables.

Battery voltage check

1. Use the VictronConnect app, a connected display or a GX device to read the solar charger battery voltage or use a multimeter to measure the battery voltage at the terminals of the controller.



Measuring battery voltage at the battery terminals of a solar charger should only be performed by a qualified electrical technician.

2. Use a multimeter to measure the voltage at the battery terminals.

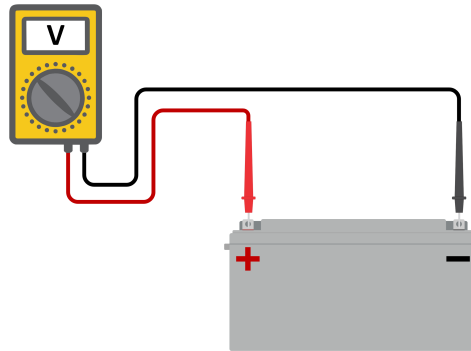

3. Compare the two voltages.
4. If the battery voltage and the controller voltage are different, then investigate why this is. Follow the path from the controller to the battery to investigate what could be the cause.

Battery connection check

1. Check and verify that all cabling is connected correctly, and that no wiring mistakes have been made.
2. Check if all cable connections are tight while taking maximum torque levels into consideration.
3. Check if all cable lugs or cable terminals have been crimped correctly.
4. Check fuses and/or circuit breakers.



If a blown fuse is found, first ensure that the battery polarity has been correctly wired before replacing the fuse. See next paragraph for more information on reverse battery polarity.

6.5.3. Battery settings too low

- In the VictronConnect app, navigate to the solar charger "Settings" menu and select the "Battery" menu.
- Check if the "Max. charge current" value is set correctly and corresponds with the battery manufacturer's recommendation.
- Check that the battery charge voltages are set according to the battery manufacturer's specifications.

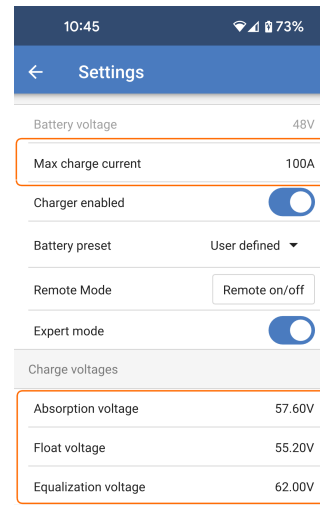

6.5.4. Reverse battery polarity

Reverse polarity is when the positive and the negative battery cable have been accidentally swapped. The battery negative has been connected to the positive solar charger terminal and the battery positive has been connected to the negative solar charger terminal.



Be aware that a red cable or positive labelled cable might not necessarily mean that the cable is indeed a positive cable. A wiring or labelling mistake could have been made during installation of the solar charger.

The solar charger is not protected against reverse battery polarity and any damage caused by this is not covered under warranty.



Always verify the battery polarity before reconnecting the battery wires to the solar charger.

6.5.5. Reverse PV polarity

As long as the unit is installed within the published specifications, the PV input is protected internally against PV reverse polarity.

In the case of reverse PV voltage, the solar charger will not indicate an error.

The only way to detect reverse PV voltage is by the following signs:

- The controller is not charging the batteries, the charge current is zero.
- The controller is getting hot.
- The PV voltage is zero, or close to zero.

If this is the case check for reverse polarity using a multimeter by ensuring that the positive PV cable is connected to the positive PV terminal, and the negative cable is connected to the negative terminal.



Measuring PV voltage at the PV terminals of a solar charger should only be performed by an electrical technician.

6.6. Batteries are undercharged

This chapter deals with possible reasons why the solar charger is not sufficiently charging the batteries and the steps you can take to check or remedy the situation.

Some signs of undercharged batteries:

- The batteries take too long to charge.
- The batteries are not fully charged at the end of the day.
- The charge current from the solar charger is less than expected.

6.6.1. Insufficient solar

Check if the solar charger reaches the float charge stage each day.

To investigate look at the history tab in the VictronConnect app. The histogram displays how long the batteries have been charged in the Bulk, Absorption and Float stage each day, for the last 30 days. If you click on one of the histogram columns you will see a breakdown of the charge stages.

You can use the charge times to see if the PV array is properly sized for your requirements.

A system that never reaches the float stage could have the following issues:

- Not enough solar panels.
- Too much load.
- A problem with the array causing it to have a reduced power output.
- For more potential reasons see paragraph: "PV power or yield less than expected".

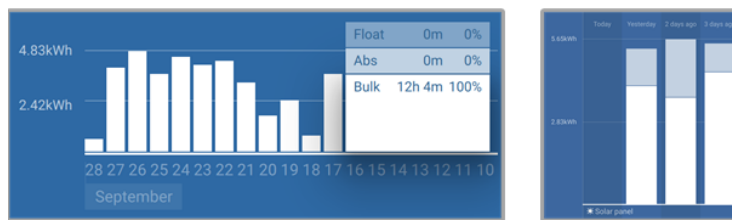

System spending all its time in bulk with breakdown of charge stages - System in bulk and absorption

6.6.2. Too much DC load

The solar charger does not only charge the batteries, it also provides power for the system's loads.

The battery will only be charged when the power available from the PV panels exceeds the power being drawn by the loads in the system, like lights, fridge, inverter, and so on.

If the system battery monitor is correctly installed and configured you can see how much current is going in (or out) of the battery and the solar charger will tell you how much current the solar array is generating.

A positive sign alongside the current reading means that current is flowing in to the battery, while a negative sign means that current is being drawn from the battery.

6.6.3. Battery cable voltage drop

If there is a voltage drop over the battery cables, the solar charger will output the correct voltage, but the batteries will receive a lower voltage which can potentially lead to undercharged batteries. A voltage drop in excess of 2.5% is unacceptable.

The voltage drop will cause the following:

- Battery charging will take longer.
- The battery receives a too-low charge voltage.
- There is a loss of charge power.
- The battery cables heat up.

The voltage drop is caused by the following:

- Battery cables with insufficient cross-sectional area.
- Badly crimped cable lugs or terminals.
- Loose terminal connections.
- Bad or loose fuse(s).

For more information on cabling issues and voltage drop see the [Wiring unlimited book](#).

Battery cable voltage drop check

This check must be performed while the charger is charging with a full current. Typically best done in the morning. Use the VictronConnect app to check the output current.

1. Measure the voltage on the battery terminals of the solar charger using the VictronConnect app or a multimeter.

2. Measure the battery voltage on the terminals of the battery using a multimeter.

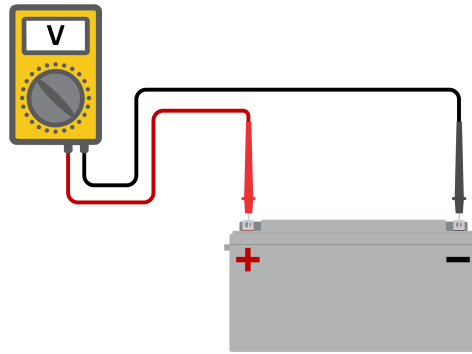

3. Compare the two voltages to see if there is a voltage difference.

6.6.4. Wrong temperature compensation setting

If the temperature compensation coefficient is set incorrectly, the batteries can be undercharged or be overcharged. The temperature compensation can be set via VictronConnect or via a display.

To find out the correct temperature compensation coefficient setting for your battery, refer to the battery documentation. When in doubt use the default value of $-64.80\text{mV}/^{\circ}\text{C}$ for lead acid batteries and disable the temperature compensation setting for lithium batteries.

6.7. Batteries are overcharged



Batteries that are being overcharged are very dangerous! There is a risk of battery explosion, fire or acid leakage. Do not smoke, create sparks or have open flames in the same room as where the batteries are located.



Overcharging batteries will cause battery damage and can be caused by:

- Incorrect charge voltage settings.
- Applying equalization while the battery is not suitable for equalization.
- High current and undersized batteries.
- Battery faults.
- Too high current, while the battery is not accepting charge anymore because of aging or prior mistreatment.

6.7.1. Battery charge voltages too high

If the battery charge voltages are set too high this will cause the batteries to overcharge.

Check if all the battery charge voltages (absorption and float) are set correctly.

The charge voltages have to match the recommended voltages as stated in the battery manufacturers documentation.

6.7.2. Battery unable to deal with equalization

During equalization, the battery charge voltage will be quite high and if the battery is unsuitable to be equalized, the battery will be overcharged.

Not all batteries can be charged with equalization voltages. Check with the battery manufacturer if the battery you are using needs a periodic equalizing charge.

Generally speaking, sealed batteries as well as lithium batteries don't need and therefore should not be equalized.

6.7.3. Battery old or faulty

A battery that is at the end of its service life or has been damaged by incorrect use, can be prone to being overcharged.

A battery contains a number of cells that are connected in series. When a battery is old or has been damaged, a likely scenario is that one of these cells is not operational anymore.

When the faulty battery is charged, the damaged cell will not accept charge and the remaining cells will receive the broken cell's charge voltage and thus will be overcharged.

To fix this, replace the battery. In case of multiple battery system replace the whole battery bank. It is not recommended to mix batteries of different ages in one battery bank.

It is hard to tell what has exactly happened to a battery during its lifetime. The solar charger will keep 30 day of battery voltage history. If the system also contains a battery monitor, or if the system is connected to VRM, the battery voltages and the cycle history of the battery can be accessed. This will give a complete picture of the battery history and it can be determined if the battery is near the end of its service life or has been abused.

To check if the battery is close to its cycle life:

1. Find out how many charge and discharge cycles the battery has been subjected to. Battery lifetime correlates to the number of cycles.
2. Check how deep the battery has been discharge on average. A battery will last for less cycles if deeply discharged, compared to more cycles if discharged less deep.
3. Refer to the battery data sheet to find out how many cycles at what average discharge the battery is capable of. Compare this with the battery history and determine if the battery is near the end of its service live.

To check if the battery has been misused:

1. Check if the battery has been totally discharged at all. Total and very deep discharge will damage a battery. Check the battery monitor setting history on the VRM portal. Look for the deepest discharge, the lowest battery voltage and the number of full discharges.
2. Check if the battery has been charged with a too high voltage. Very high charge voltage will damage the battery. Check the maximum battery voltage and the high voltage alarms in the battery monitor. Check if the measured maximum voltage has exceeded the battery manufacturer recommendations.

6.8. PV problems

This chapter deals with the remaining solar problems that were not already discussed in the earlier chapters.

6.8.1. PV yield less than expected

Check the solar charger history in the VictronConnect app. Check the total maximum power (Pmax) for each day. Does this match the array power?

To find the potential solar yield per day for a specific PV array size in a specific geographical location, use the MPPT sizing calculator on the [solar charge controller product page](#).

These are some of the reasons why the array is generating less power than expected:

- Low sun angle, seasonal differences or morning/evening.
- Cloud cover or bad weather.
- Shading from trees or buildings.
- Dirty panels.
- Incorrect orientation and/or inclination.
- Broken or faulty solar panel(s).
- Issues with wiring, fuses, circuit breakers, wiring voltage drop.
- Bad splitters or combiners, or these are used in an incorrect way.
- Part of the PV array not working.
- PV array design issues.
- Solar array configuration mistakes.
- The batteries are too small, or getting older, and have a reduced capacity.

The VictronConnect App can be used to see what the maximum PV power was for any of the last thirty days. This information could be used to diagnose problems with less than expected PV power or daily yield.

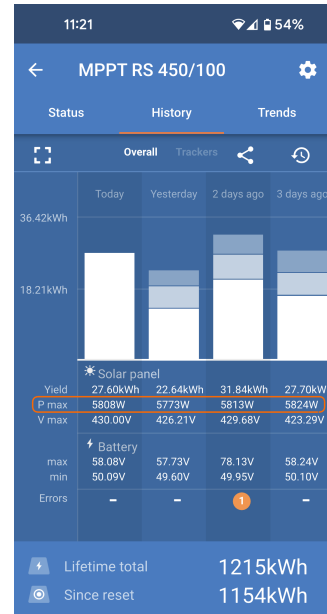

6.8.2. Full rated output not reached

There are a few reasons why the solar charger is not reaching its full rated output.

Some of these reasons have already been explained in the the chapter: “The batteries take too long to charge, are undercharged or charge current less than expected”. Some additional reasons are explained in this paragraph.

6.8.3. Mixed PV panel types

It is not recommended to connect a mix of different PV panel types to the same solar charger.

Only use solar panels that are the same brand, type and model.

6.8.4. MC4 connectors wrongly connected

For a detailed explanation of how to connect MC4 connectors, MC4 splitters and MC4 combiners, see the [Wiring unlimited book](#), chapter: “Solar panels”.

6.8.5. PV connections burned or melted

Burned or melted PV cables or connections are generally not covered under warranty. In most case this is due to any of the following reasons:

Solar cable

- Cables with rigid core wire or rigid strands used.
- Cables where the core wire has been soldered.
- Cable too thin - remember that the current will be higher when the PV voltage is lower. For more information on cable thickness see the [Wiring Unlimited book](#).

6.8.6. Optimisers cannot be used

Do not use solar panels with optimisers together with the solar charger.

Nearly all optimisers contain an MPPT or other tracking mechanisms and this interferes with the MPPT algorithm in the solar charger.

6.8.7. Ground current

The system should not have a current flowing to ground under normal operation.

If a ground current is detected, first investigate all the equipment connected to that system and check for ground faults.

Next, check how many connections to ground the system has. There should only be a single point in the system connected to ground . This should be at the battery.

For more information on system grounding, see the "System grounding" chapter in the [Wiring Unlimited book](#).

The SmartSolar MPPT RS connection between PV DC and battery DC is fully galvanically isolated.

6.8.8. PV voltage too high

The PV voltage should never exceed the maximum rated PV voltage of the solar charger. The maximum PV voltage rating is printed on the front or on the side of the housing of the controller, and in the product specification sheets.

The solar charger stops charging if the PV voltage exceeds the maximum rated PV voltage. At the same time, it will display an overvoltage error #33, and will fast blink its absorption and float LED.

Charging will not recommence until the PV voltage has dropped 5V below the rated maximum voltage.

When investigating a high voltage issue, also look at the history of the VictronConnect app, solar charger display or GX device. Check the highest PV voltage for each day (Vmax) and also look for past overvoltage warnings.

Check the open circuit voltage (Voc) rating of the PV array. Ensure that it is less than the maximum rated voltage of the solar charger. Use the MPPT sizing calculator on the [solar charger product page](#). In case the PV array is located in cold climates or if the night temperature drops close to or below 10°C the PV array can output more than its rated Voc. As a rule of thumb, keep an additional 10% safety margin.

An overvoltage event can damage the solar charger, depending on how much the maximum PV voltage was exceeded. This damage is not covered by warranty.

6.9. Communication problems

This chapter describes issues that might arise when the SmartSolar MPPT RS is connected to the VictronConnect app, other Victron devices or third-party devices.

6.9.1. VictronConnect app



For operational issues of the VictronConnect app, like the app will not run or is unable to connect to the solar charger, see the general [VictronConnect manual](#).

6.9.2. Bluetooth

Please note that it is highly unlikely that the Bluetooth interface is faulty. The problem is most likely caused by something else. Use this chapter to quickly rule out some of the common causes of Bluetooth issues.

For a full troubleshooting guide see the [VictronConnect manual](#).

- **Check if Bluetooth is enabled**

It is possible to enable/disable Bluetooth in the product settings. To re-enable:

Connect to the solar charger via the VE.Direct port.

Navigate to the controller settings and then to "product info".

Re-enable Bluetooth.

- **Check if the controller is powered-up**

Bluetooth is active as soon as the solar charger is powered-up.

- **Check that Bluetooth is in range**

In open space the maximum Bluetooth distance is about 20 meters. In a build-up area, inside a house, a shed, a vehicle or a boat this distance can be a lot less.

- **The Windows VictronConnect app does not support Bluetooth**

The Windows version of the VictronConnect app does not support Bluetooth. Use an Android, iOS or macOS device instead. Or alternatively connect using a [VE.Direct to USB interface](#).

- **The controller is missing in the VictronConnect app device list**

Some steps to try to resolve this issue are:

Press the orange refresh button at the bottom of the VictronConnect app device list and check if the solar charger is now listed. Only one phone or tablet can be connected to the solar charger at any given time. Make sure no other devices are connected and try again.

Try to connect to another Victron product, does this work? If that also does not work, there probably is an issue with the phone or tablet.

Rule out any issues with the phone or the VictronConnect app by using another phone or tablet and try again.

If still unresolved, refer to the [VictronConnect app manual](#).

- **PIN code lost**

If you have lost the PIN code, you will need to reset the PIN code to its default PIN code. This is done in the VictronConnect app:

Navigate to the device list of the VictronConnect app.

Enter the solar charger's unique PUK code as printed on its product information sticker.

Click on the option symbol next to the solar charger listing.

A new window will open which allows you to reset the PIN code back to its default: 000000.

- **How to communicate without Bluetooth**

In case Bluetooth is not functional, turned off or unavailable, the VictronConnect app can still communicate via the unit's VE.Direct port. Or, if the unit is connected to a GX device, the VictronConnect app can communicate via VRM. For more information see the [VictronConnect app](#) chapter.

6.9.3. VE.Direct port

These are not common and if this occurs it is probably due to one of these issues listed in this paragraph.

Physical cable connector or data port issues Try a different VE.Direct cable and see if the unit will now communicate. Is the connector inserted properly and deep enough? Is the connector damaged? Inspect the VE.Direct port, are there bent pins? If this is the case, use long nose pliers to straighten the pins, while the unit is unpowered.

6.10. Error code overview

The error codes are displayed on the VictronConnect app, display or connected GX device.

For the most up-to-date version of this list see this link: <https://www.victronenergy.com/live/mppt-error-codes>.



Note that not all of these errors might apply to your product. Some error types only apply to solar chargers, DC-DC chargers or AC chargers or are specific only to certain models within a charger group.

Error 2 - Battery voltage too high

- This error will auto-reset after the battery voltage has dropped. This error can be due to other charging equipment connected to the battery or a fault in the charge controller.

Error 3, Error 4 - Remote temperature sensor failure

- Check if the T-sense connector is properly connected to a remote temperature sensor. Most likely cause: the remote T-sense connector is connected to the BAT+ or BAT- terminal. This error will auto-reset after proper connection.

Error 5 - Remote temperature sensor failure (connection lost)

- Check if the T-sense connector is properly connected to a remote temperature sensor. This error will not auto-reset.

Error 6, Error 7 - Remote battery voltage sense failure

- Check if the V-sense connector is properly connected to the battery terminals. Most likely cause: the remote V-sense connector is connected in reverse polarity to the BAT+ or BAT- terminals.

Error 8 - Remote battery voltage sense failure (connection lost)

- Check if the V-sense connector is properly connected to the battery terminals.

Error 11 - Battery high ripple voltage

- High DC ripple is usually caused by loose DC cable connections and/or too thin DC wiring. After the inverter has switched off due to high DC ripple voltage, it waits 30 seconds and then restarts.

After three restarts followed by a shutdown due to high DC ripple within 30 seconds of restarting, the inverter will shutdown and stops retrying. To restart the inverter, switch it Off and then On.

Continuous high DC ripple reduces the inverter life expectancy

Error 14 - Battery low temperature

- The charger is stopped to avoid charging LiFePO4 batteries at low temperature as this damages the cells.

Error 17 - Controller overheated despite reduced output current

- This error will auto-reset after charger has cooled down. Check the ambient temperature and check for obstructions near the heat sink.

Error 18 - Controller over-current

- This error will auto-reset. If the error does not auto-reset disconnect the charge controller from all power-sources, wait 3 minutes, and power up again.

Possible causes for an over-current on the battery terminals:

- switching on/off a very large load on the battery side.
- sudden change in irradiance causing a temporary over-power in the mppt.
- overloading the inverter ac output.

Possible solutions:

- if possible provide adequate cooling for the unit, a cooler unit can handle more current.
- reduce the load on the inverter.
- charge the battery before using the inverter, at higher battery voltages the same amount of power requires less current.

Error 20 - Maximum Bulk-time exceeded

- For solar chargers:

The maximum bulk time protection is a feature that was in the chargers when they were just released (2015 or earlier) and later the feature was removed.

If you do see this error, then update to the latest firmware.

If you then still have the error, perform a reset to factory defaults of the configuration, and reconfigure the solar charger.

Error 21 - Current sensor issue

- The current measurement is out of range.

Disconnect all wires, and then reconnect all wires, to make the charger restart. Also, make sure the minus on the MPPT charge controller (PV minus/Battery minus) is not bypassing the charge controller.

This error will not auto-reset.

If the error remains, please contact your dealer, there might be a hardware defect.

Error 22, Error 23 - Internal temperature sensor failure

- The internal temperature measurements are out of range.

Disconnect all wires, and then reconnect all wires, to restart the unit.

This error will not auto-reset.

If the error remains, please contact your dealer, there might be a hardware defect.

Error 27 - Charger short circuit

- This condition indicates an over-current condition on the battery side. It can occur when a battery is attached to the unit using a contactor. Or in case the charger starts up without a battery connected but connected to an inverter that has a large input capacitance.

This error will auto-reset. If the error does not auto-reset disconnect the charge controller from all power-sources, wait 3 minutes, and power up again. If the error persists the charge controller is probably faulty.

Error 29 - Over-Charge protection

- This error will auto-reset once the battery voltage drops below the float voltage. To protect the battery from over-charging the battery is disconnected.

Possible causes:

- over-sized PV array configuration, if there are too many panels in series the battery voltage cannot be reduced any further. Consider wiring more PV panels in parallel to reduce the voltage.
- configuration issue, check if the battery settings match with the installation (especially absorption and float voltage settings).
- another charger in the system raises the battery voltage above the expected level.

Error 33 - PV over-voltage

- This error will auto-reset after PV-voltage has dropped to safe limit.

This error is an indication that the PV-array configuration with regard to open-circuit voltage is critical for this charger. Check configuration, and if required, re-organise panels.

Error 34 - PV over-current

- The current from the solar-panel array has exceeded the maximum allowed current.

This error could be generated due to an internal system fault.

Disconnect the charger from all power-sources, wait 3 minutes, and power-up again. If the error persists the controller is probably faulty, contact your dealer.

Error 35 - PV over-power

- Applies to the MPPT RS, Inverter RS and Multi RS products.

Please upgrade your firmware to at least v1.08 as the issues causing this error have been addressed.

If you are using firmware v1.08 or newer this error indicates that the internal dc voltage is too high. This error will auto-reset.

If the error does not auto-reset disconnect the charge controller from all power-sources, wait 3 minutes, and power up again. If the error persists the charge controller is probably faulty.

Error 41 - Inverter shutdown (PV isolation)

- PV panel isolation resistance too low. Check the PV array cabling and panel isolation, the inverter restarts automatically once the issue is resolved.

Error 42 - Inverter shutdown (PV isolation)

- The ground leakage current in the PV array exceeds the allowed 30mA limit. Check the PV array cabling and panel isolation. Check the installation and restart the unit using the power-switch.

Error 43 - Inverter shutdown (Ground Fault)

- The voltage difference between Neutral and Ground is too high.

Inverter or Multi (not connected to the grid):

- The internal ground relay is activated but the voltage over the relay is too high. The relay might be damaged.

Multi (connected to the grid):

- The ground wire in the installation is not present or not connected properly.
- Line and Neutral are swapped in the installation.

This error will not auto-reset. Check the installation and restart the unit using the power-switch.

Error 50, Error 52 - Inverter overload, Inverter peak current

- Some loads like motors or pumps draw large inrush currents in a start-up situation. In such circumstances, it is possible that the start-up current exceeds the over current trip level of the inverter. In this case the output voltage will quickly decrease to limit the output current of the inverter. If the over current trip level is continuously exceeded, the inverter will shut down: wait 30 seconds and then restart.

The Inverter can supply more power than the nominal power level for a short time. If the time is exceeded the inverter stops.

After three restarts followed by another overload within 30 seconds of restarting, the inverter will shutdown and remain off. To restart the inverter, switch it Off, then On.

If the error persists reduce the load on the AC out terminal by switching off or disconnecting appliances.

Error 51 - Inverter temperature too high

- A high ambient temperature or enduring high load may result in shut down to over temperature. Reduce load and/or move inverter to better ventilated area and check for obstructions near the fan outlets.

The inverter will restart after 30 seconds. The inverter will not stay off after multiple retries.

Error 53 - Inverter output voltage

- If the battery voltage is getting low and a large load is applied to the AC output the inverter is unable to maintain the proper output voltage. Re-charge the battery or reduce the AC loads to continue operation.

Error 54 - Inverter output voltage

- If the battery voltage is getting low and a large load is applied to the AC output the inverter is unable to maintain the proper output voltage. Re-charge the battery or reduce the AC loads to continue operation.

If the error immediately pops up when switching on the inverter (without load) on a full battery the cause is most likely a broken internal fuse.

Error 55, Error 56, Error 58 - Inverter self test failed

- The inverter performs diagnostic tests before it activates its output. In the case that one of these tests fails an error message is displayed and the inverter does not turn on.

First try to restart the inverter, by switching it Off, and then On. If error persists the inverter is probably faulty.

Error 57 - Inverter ac voltage on output

- There is already AC voltage on the AC out terminal before switching on the inverter. Check that the AC out is not connected to a mains outlet or to another inverter.

This error will not auto-reset. Check the installation and restart the unit using the power-switch.

Err 59 - ACIN1 relay test fault

- Automatic checking of the disconnect means failure. This usually indicates a broken relay (sticky contact) in the AC input stage.

Try to restart the SmartSolar MPPT RS by switching it off and then on again at the rocker switch. If the error persists then a relay is likely to be faulty.

Information 65 - Communication warning

- Communication with one of the paralleled chargers was lost. To clear the warning, switch the charger off and back on.

Information 66 - Incompatible device

- The controller is being paralleled to another controller that has different settings and/or a different charge algorithm.

Make sure all settings are the same and update firmware on all chargers to the latest version.

Error 67 - BMS Connection lost

- This error shows when the charger is configured to be controlled by a BMS, but does not receive any BMS control messages. In that situation, the charger stops charging by reducing its output voltage to the battery base voltage (12V/24V/36V/48V). This is a safety mechanism, the reason to still enable the output is to allow a system to self-recover from a battery low situation.

Solar Chargers only show this error when there is solar power available and thus the device is ready to initiate charging. It does not show at night. And in case there is a permanent problem, the error will raise in the morning and clear at night, and so forth.

Solution: check the connection between the charger and the BMS.

[How to reconfigure the charger to standalone mode:](#)

Our Chargers and Solar Chargers automatically configure themselves to be BMS-controlled when they are connected to one; either direct or via a GX Device. And that setting is semi-permanent: power cycling the charger will not reset it.

When removing charger from such system, and reusing it in a system without BMS, that setting needs to be cleared. Here is how to do that:

- Chargers with LCD display: go into the setup menu, and change setting 'BMS' from 'Y' to 'N' (setup item 31).
- Other chargers: reset the charger to factory defaults with VictronConnect, and then reconfigure it.

Error 68 - Network misconfigured

- Applies to SmartSolar/BlueSolar chargers VE.Can (FW version v1.04 or higher) and SmartSolar VE.Direct chargers (FW version v1.47).

To clear the error on the SmartSolar VE.Direct chargers update the FW version to v1.48 or higher.

To clear the error on the SmartSolar/BlueSolar chargers VE.Can, update the software. If the error persists, it will be because the charger is connected with both a VE.Direct cable and on VE.Can. That is not supported. Remove one of the two cables. The error will disappear and the charger will resume normal operation, within a minute.

Background:

Error 68 indicates that the charger detects multiple conflicting network sources, with the same priority, trying to send the same information to the charger. VE.Can and VE.Direct interfaces have both the same priority level, and BLE (using VE.Smart Networking) has a lower priority.

Having a higher priority level means that, if the same information (e.g. Battery voltage sense) is being received from both VE.Can and BLE (using VE.Smart Network) by the charger, the information on VE.Can will be used and the one coming from BLE will be ignored.

Now, if the same information is being received from two interfaces that have the same priority level (as VE.Can and VE.Direct), the charger does not know how to prioritize those, causing error 68 to be triggered.

Error 69 - Network misconfigured

- Applies to Inverter RS and Multi RS models. Firmware versions 1.11 and higher.

This error indicates an issue in the configuration. There are units present on the same can bus that have different system configurations. Please ensure that all units are set to either "Single Phase" or "Three Phase". All units will remain off until the configuration is fixed, after which the units will resume operation.

Error 70 - Network misconfigured

- Applies to Inverter RS models. Firmware versions 1.11 and higher.

The Inverter RS model used cannot be paired with a Multi RS and/or Transfer Switch. Only Inverter RS models with a production code newer than HQYYWW can be used for this purpose. Only the incompatible Inverter RS units will remain off.

Error 71 - Network misconfigured

- Applies to Inverter RS and Multi RS models. Firmware versions 1.11 and higher

There are units present with incompatible firmware on the can bus. Make sure that all units are updated to the same firmware version. All units will remain off until the until the firmwares are updated, after which the units will resume operation.

Error 114 - CPU temperature too high

- This error will reset after the CPU has cooled down. If the error persists, check the ambient temperature and check for obstructions near the air inlet and outlet holes of the charger cabinet. Check manual for mounting instructions with regard to cooling. If error persists the controller is probably faulty.

Error 116 - Calibration data lost

- If the unit does not work and error 116 pops up as the active error, the unit is faulty. Contact your dealer for a replacement.

If the error is only present in the history data and the unit operates normally this error can be ignored safely. Explanation: when the units power up for the very first time in the factory, it does not have calibration data and an error 116 is logged. Obviously this should have been cleared, but in the beginning units left the factory with this message still in the history data.

SmartSolar models (not the BlueSolar models): upgrading to v1.4x firmware is a one-way trip, you cannot go back to an older firmware version once you upgrade to v1.4x. Reverting to older firmware gives error 116 (calibration data lost), this can be fixed by re-installing the v1.4x firmware.

Error 117 - Incompatible firmware

- This error indicates that a firmware update did not complete, so the device is only partially updated. Possible causes are: device out of range when updating over the air, a cable got disconnected or power was lost during the update session.

To fix this the update needs to be retried, download the correct firmware for your device from the [Victron Professional Portal](#)

When your GX device is connected to VRM, you can do a remote firmware update using this firmware file. You can do this via the VRM website or using the VRM tab in VictronConnect. VictronConnect can also be used together with the firmware file to update using a Bluetooth connection.

The procedure to add the file to VictronConnect and start the update is described here: [9. Firmware updates](#)

Error 119 - Settings data lost

- The charger cannot read its configuration, and stopped.

This error will not auto-reset. To get it working again:

1. First, restore it to factory defaults. (top right in Victron Connect, click on the three dots)
2. Disconnect the charge controller from all power-sources
3. Wait 3 minutes, and power up again.
4. Reconfigure the charger.

Please do report this to your Victron dealer and ask him to escalate it to Victron; as this error should never happen. Preferably include firmware version and any other specifics (VRM URL, VictronConnect screenshots or similar).

Error 121 - Tester fail

- If the unit does not work and error 121 pops up as the active error the unit is faulty, contact your dealer for a replacement.

If the error is only present in the history data and the unit operates normally this error can be ignored safely. Explanation: when the units powers up for the very first time in the factory, it does not have calibration data and an error 121 is logged. Obviously this should have been cleared, but in the beginning units left the factory with this message still in the history data.

Error 200 - Internal DC voltage error

- The unit performs internal diagnostics when activating its internal DC-DC converter. This error indicates that something is wrong with the DC-DC converter.

This error will not auto-reset. Check the installation and restart the unit using the power-switch. If the error persists the unit is probably faulty.

Error 201 - Internal DC voltage error

- This "Internal DC voltage measurement error", is raised in case an internal (high-) voltage measurement does not match certain criteria.

First, make sure to update the firmware to v1.08 or later. The limits were too strict in earlier versions. And it could trigger falsely during MPPT start-up in the morning and MPPT shutdown in the evening.

If the error still occurs after updating to v1.08 or later, then it means that a measurement circuit inside the unit is broken.

This error will not auto-reset. Check the installation and restart the unit using the power-switch. If the error persists, even after above mentioned firmware update, the unit is most likely faulty and must be sent in for repair/replacement.

Error 202 - Internal GFCI sensor error

- The sensor used to measure residual current did not pass the internal self test.

This error will not auto-reset. Check the installation and restart the unit using the power-switch. If the error persists the unit is probably faulty and must be sent in for repair/replacement.

Error 203, Err 205, Err 212, Err 215 - Internal supply voltage error

- The unit performs internal diagnostics when activating its internal voltage supplies. This error indicates that something is wrong with an internal supply voltage.

This error will not auto-reset. Check the installation and restart the unit using the power-switch. If the error persists the unit is probably faulty.

7. Technical Specifications

Isolated SmartSolar MPPT RS	450/100-MC4	450/200-MC4
CHARGER		
Programmable charge voltage range	Minimum: 36 V Maximum: 60 V ⁽⁸⁾	
Charge voltage 'absorption'	Default : 57.6 V (adjustable)	
Charge voltage 'float'	Default : 55.2 V (adjustable)	
Maximum charge current	100 A	200 A
Battery temperature sensor	Included	
Battery voltage sense	Yes	
SOLAR		
Maximum DC PV voltage	450 V	
Start-up voltage	120 V	
MPPT operating voltage range	65 – 450 V ⁽¹⁾	
Number of MPP Trackers	2	4
Maximum operational PV input current	16 A per tracker	
Max. PV short circuit current reverse polarity protection ⁽²⁾	20 A per tracker	
Maximum DC output charging power	4000 W per tracker 5760 W total	4000 W per tracker 11520 W total
Maximum PV array size per tracker ⁽³⁾	7200 Wp (450 V x 20 A)	
PV Isolation fail level ⁽⁴⁾	100 kΩ	
GENERAL		
Synchronised Parallel Operation	Yes, up to 25 units with VE.Can	
Programmable relay ⁽⁵⁾	Yes	
Protection ⁽⁶⁾	c, d, e	
Data Communications	VE.Direct port, VE.Can port & SmartSolar Bluetooth ⁽⁷⁾	
Bluetooth frequency	2402 – 2480 MHz	
Bluetooth power	4dBm	
General purpose analog/digital in port	Yes, 2x	
Remote on-off	Yes	
Operating temperature range	-40 to +60°C (fan assisted cooling)	
Humidity (non-condensing)	max 95%	
Environmental condition	Indoor type 1, conditioned	
Suitable for wet locations	No	
Pollution degree	PD2	
Maximum altitude	2000m	
Over voltage category	OVCII	
ENCLOSURE		
Material & Color	steel, blue RAL 5012	

Isolated SmartSolar MPPT RS	450/100-MC4	450/200-MC4
Protection category	IP21	
Battery-connection	Two M8 bolts, 1x Positive and 1x Negative	Four M8 bolts, 2x Positive and 2x Negative
Power terminals PV input	MC4 Connectors	
Weight	7.9 kg	13.7 kg
Dimensions (hwxwd)	442 x 310 x 127 mm	487 x 435 x 147 mm
STANDARDS		
Safety	EN-IEC 62109-1	
Country of Origin	Designed in The Netherlands, Made in India	
<p>¹⁾ MPPT operating range is also constrained by battery voltage - PV VOC should not exceed 8xbattery float voltage. For example, a 52,8V float voltage results in a maximum PV VOC of 422,4V. See Solar array configuration [10] for further information.</p> <p>²⁾ A higher short circuit current may damage the controller if PV array is connected in reverse polarity.</p> <p>³⁾ Max. 450 Voc result in appr. 360 Vmpp, therefor the maximum PV array is appr. 360V x 20A = 7200Wp</p> <p>⁴⁾ The SmartSolar MPPT RS will test for sufficient resistive isolation between PV+ and GND, as well as PV- and GND. If the resistance falls below the threshold, the unit will report an error and send an error signal to the GX device (if connected) for audible and email notifications. Despite the error, the product will continue charging the battery.</p> <p>⁵⁾ Programmable relay which can be set for general alarm, DC under voltage or genset start/stop function. DC rating: 4A up to 35VDC and 1A up to 70VDC</p> <p>⁶⁾ Protection key:</p> <p>c) battery voltage too high</p> <p>d) battery voltage too low</p> <p>e) temperature too high</p> <p>⁷⁾ The MPPT RS is not currently compatible with VE.Smart Networks</p> <p>⁸⁾ The Charger set-point (float and absorption) can be set to max 60 V. The output voltage at the charger terminals can be higher, due to temperature compensation as well as compensation for voltage drop over the battery cables. The maximum output current is reduced on a linear basis from full current at 60V to 5A at 62V. The equalization voltage can be set to max 62V, the equalization current percentage can be set to max 6%.</p>		

7.1. Compliance

SIMPLIFIED EU DECLARATION OF CONFORMITY: Hereby, Victron Energy B.V. declares that the SmartSolar MPPT RS is in compliance with Directive 2014/53/EU. The full text of the EU declaration of conformity is available at the following internet address: <https://ve3.nl/7R>.

UK PSTI STATEMENT OF COMPLIANCE: We, Victron Energy B.V., confirm that our product SmartSolar MPPT RS complies with the security requirements outlined in Schedule 1 of The Product Security and Telecommunications Infrastructure (Security Requirements for Relevant Connectable Products) Regulations 2023. The official Statement of Compliance can be downloaded from <https://ve3.nl/7R>.

8. Appendix

8.1. Appendix B : Block Diagram

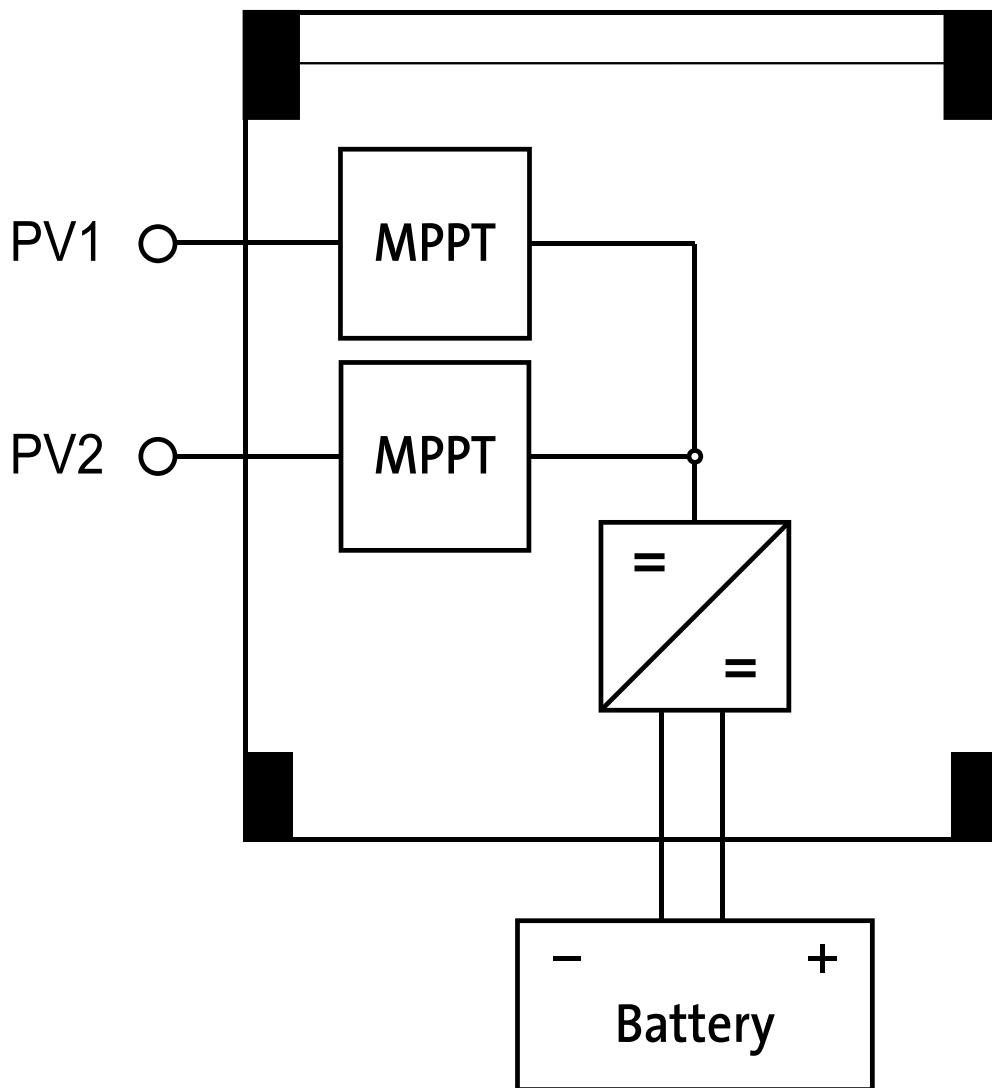

8.2. Appendix C : Example system schematic and wiring diagram

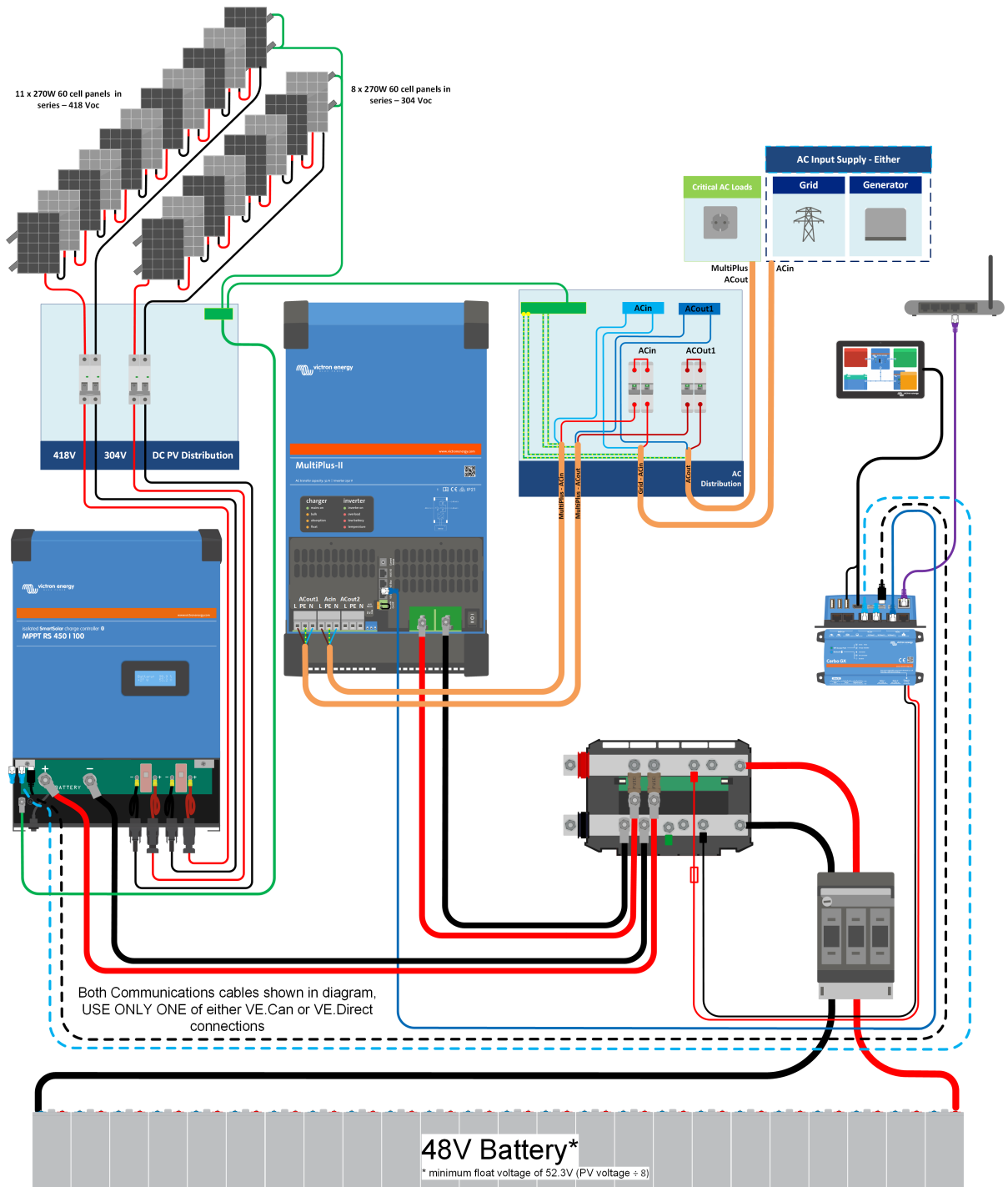

8.3. Appendix D : Dimensions

