

Multi RS Solar

Table of Contents

1. Multi RS Solar Product Manual	1
2. Safety Instructions	2
3. General Description	4
3.1. Two AC outputs	4
3.2. PowerControl - maximum use of limited AC power	4
3.3. PowerAssist - extended use of AC input current	4
3.4. Programmable	4
3.5. Programmable relay	4
3.6. Programmable analog/digital input/output ports	4
3.7. Built-in Battery Monitor	4
3.8. High efficiency	5
3.9. Frequency shift function	5
3.10. High power inverter	5
3.11. Galvanically isolated battery	5
3.12. PV Inverter only mode	5
3.13. Interfacing and Communications	6
3.14. Battery charger	6
3.14.1. Lead-acid batteries	6
3.14.2. Li-ion batteries	7
3.14.3. More on batteries and battery charging	7
3.15. Setup options	7
3.16. Limitations	8
4. Installation	9
4.1. Location of the Multi RS Solar	9
4.2. Battery and battery lead requirements	10
4.3. Solar array configuration	11
4.3.1. Multi RS Solar example PV configuration	11
4.4. MPPT grounding, detection of PV array insulation faults & Earth fault alarm notification	11
4.5. Cable connection sequence	12
4.6. Battery connection procedure	12
4.7. Connection of AC cabling	13
4.8. VE.Direct	14
4.9. VE.Can	14
4.10. Bluetooth	14
4.11. User I/O	15
4.11.1. Remote H and L terminals	15
4.11.2. Programmable relay	17
4.11.3. Voltage sense	17
4.11.4. Temperature sensor	17
4.11.5. Auxiliary inputs	18
4.12. Generator programming	19
4.13. ESS - Energy Storage System	21
4.14. Connecting to external AC PV inverters	25
4.15. PV Inverter configuration	25
4.16. Connecting an external energy meter	26
4.17. Large systems - 3 phase	28
4.18. 3 phase installation	29
4.19. 3 phase programming	30
5. VictronConnect setup, configuration and operation	33
5.1. Setup	33
5.2. Overview page	34
5.3. Settings page	38
5.4. Product info	39
5.5. General	40
5.6. Grid	42
5.7. Battery	43
5.8. Solar	48
5.9. Inverter	49
5.10. Relay	50

5.11. Aux Input	53
5.12. Display	54
5.13. AC input control	55
5.14. ESS	57
5.15. System	59
6. Operation	62
6.1. Device display	62
6.2. Protections and automatic restarts	63
6.2.1. Overload	63
6.2.2. Low battery voltage thresholds (adjustable in VictronConnect)	63
6.2.3. High battery voltage	63
6.2.4. High temperature	63
7. Troubleshooting guide	64
7.1. Solar charger is inactive	64
7.1.1. PV voltage too low	64
7.1.2. Reverse PV polarity	64
7.1.3. Safety relays are closed	65
7.2. Batteries are not being charged	65
7.2.1. Battery is full	65
7.2.2. Battery settings too low	66
7.2.3. Reverse PV polarity	66
7.3. Batteries are undercharged	66
7.3.1. Insufficient solar	66
7.3.2. Too much DC load	67
7.3.3. Battery cable voltage drop	67
7.3.4. Wrong temperature compensation setting	68
7.4. Batteries are overcharged	68
7.4.1. Battery charge voltages too high	68
7.4.2. Battery unable to deal with equalization	68
7.4.3. Battery old or faulty	68
7.5. PV problems	69
7.5.1. PV yield less than expected	69
7.5.2. Full rated output not reached	70
7.5.3. Mixed PV panel types	70
7.5.4. MC4 connectors wrongly connected	70
7.5.5. PV connections burned or melted	70
7.5.6. Optimisers cannot be used	70
7.6. Communication problems	71
7.6.1. Bluetooth	71
7.6.2. VE.Direct port	71
7.6.3. VE.Smart communication	72
7.7. Error code overview	73
8. Technical Specifications	78
9. Appendix	81
9.1. Appendix A : Connection Overview	82
9.2. Appendix B : Block Diagram	84
9.3. Appendix C : Example Wiring Diagram	84
9.4. Appendix D : Dimensions	86

1. Multi RS Solar Product Manual

Introduction

The Victron Multi RS Solar integrates the following elements:

- A powerful inverter/charger
- Two high power solar MPPT trackers

This document explains:

- Features
- Behaviour
- Specifications
- Limitations
- Installation instructions
- Troubleshooting steps

You must read it to understand how to use your product safely and reliably.

This manual applies to:

- Multi RS Solar 48/6000/100-450/100 - PMR482602020



IMPORTANT - The Multi RS Solar has limitations and restrictions that are subject to change with updates to firmware - please contact your Victron Dealer or Victron Sales Manager prior to purchase to understand these limitations and if this product is suitable for your specific application. For example, generator input support requires a v1.11 firmware update.

2. Safety Instructions



ELECTRIC SHOCK HAZARD

Please read this manual carefully before the product is installed and put into use.

This product is designed and tested in accordance with international standards. The equipment should be used for the designated application only.

Refer to the specifications provided by the manufacturer of the battery to ensure that the battery is suitable for use with this product. The battery manufacturer's safety instructions should always be observed.

Protect the solar modules from incident light during installation, e.g. cover them.

Never touch uninsulated cable ends.

Use only insulated tools.

Connections must always be made in the sequence described in the installation section of this manual.

The installer of the product must provide a means for cable strain relief to prevent the transmission of stress to the connections.

In addition to this manual, the system operation or service manual must include a battery maintenance manual applicable to the type of batteries used. The battery must be placed in a well-ventilated area.

These servicing instructions are for use by qualified personnel only. To reduce the risk of electric shock, do not perform any servicing other than that specified in the operating instructions unless you are qualified to do so.

The product is used in combination with a permanent energy source (a battery). Even if the equipment is switched off, a dangerous electrical voltage can occur at the input and/or output terminals. Always switch the AC power off and disconnect the battery before performing maintenance.



SELECTION OF WIRE CONDUCTORS

Use flexible multistranded copper cable for the battery and PV connections.

The maximum diameter of the individual strands is 0,4mm/0,125mm² (0.016 inch/AWG26).

A 25mm² cable, for example, should have at least 196 strands (class 5 or higher stranding according to VDE 0295, IEC 60228 and BS6360).

An AWG2 gauge cable should have at least 259/26 stranding (259 strands of AWG26)

Maximum operating temperature: $\geq 90^{\circ}\text{C}$

Example of suitable cable: class 5 "Tri-rated" cable (it has three approvals: American (UL), Canadian (CSA) and British (BS)).

In case of thicker strands the contact area will be too small and the resulting high contact resistance will cause severe overheating, eventually resulting in fire.



RISK OF INJURY OR DEATH

The internals can carry a 400-500V DC voltage even when the product is off!

Input and/or output terminals may still be dangerously energized, even when the equipment is switched off. Always disconnect all power connections (e.g. the battery, DC solar isolator, etc) and wait at least 5 minutes before carrying out work on the product.

The product has no internal user-serviceable components. Do not remove the front plate or operate the product if any panels have been removed. All servicing must be undertaken by qualified personnel.

Please read the installation instructions in the installation manual before installing the equipment.

This is a Safety Class I product (supplied with a protective grounding terminal). The chassis must be grounded. Whenever it is likely that the grounding protection has been damaged, the product must be turned off and secured against unintended operation; please contact qualified service staff.

Non-isolated inverters shall be provided with installation instructions that require PV modules that have an IEC 61730 Class A rating.

If the maximum AC mains operating voltage is higher than the PV array maximum system voltage, then the instructions shall require PV modules that have a maximum system voltage rating based upon the AC mains voltage.

Environment and Access

Ensure that the equipment is used under the correct ambient conditions. Never operate the product in a wet or dusty environment. Never use the product where there is a risk of gas or dust explosions. Ensure there is adequate free space for ventilation above and below the product and check that the ventilation vents are not blocked.





Ensure that the unit is installed on a non-flammable surface and that surrounding construction materials are also made of non-flammable materials.

Installation of this product must be in a location that restricts access by persons (including children) with reduced physical, sensory or mental capabilities, or lack of experience and knowledge, unless they have been given supervision or instruction concerning use of the appliance by a person responsible for their safety.

The connections to live parts should be covered after installation.

Ensure that no flammable materials or objects will be stored close to the installation after it has been commissioned.

Enclosure Symbols

Symbol on the enclosure	
	<p>Caution, risk of electric shock</p>
	<p>Refer to the operating instructions</p>
<p>IP21</p>	<p>IP21 Protected from touch by fingers and objects greater than 12 millimetres. Protected from condensation.</p>
	<p>European conformity</p>
	<p>Regulatory compliance mark for Australia & New Zealand</p>

3. General Description

The Multi RS Solar is a combined inverter/charger and MPPT solar charger.

It is designed to operate with a 48V battery bank and produces a pure AC sine wave at 230V.

3.1. Two AC outputs

Besides the usual uninterruptible output (AC-out-1), an auxiliary output (AC-out-2) is available that disconnects its load in the event of battery-only operation. Example: an electric boiler that is allowed to operate only if the AC input is available. There are several applications for AC-out-2.

3.2. PowerControl - maximum use of limited AC power

The product can supply a huge charging current. This implies heavy loading of the AC input. Therefore a maximum current can be set. The product then takes other power users into account, and only uses 'surplus' current for charging purposes.

3.3. PowerAssist - extended use of AC input current

This feature takes the principle of PowerControl to a further dimension allowing the product to supplement the capacity of the alternative source. Where peak power is often required only for a limited period, the product will make sure that insufficient AC input power is immediately compensated for by power from the battery. When the load reduces, the spare power is used to recharge the battery.

The Multi RS can provide throughput of up to 50 A to the loads. The AC input relays are limited to 50 A (Multi RS - 2 tracker), and the inverter can contribute up to 25 A continuous at best conditions (when it gets hotter this figure will be reduced).

This power comes from either the battery and/or the DC PV (the DC PV power also has to go through the inverter before it reaches the AC loads).

3.4. Programmable

All programmable settings and grid-interactive setpoints for this product can be changed with either a mobile phone or computer (Windows requires VE.Direct to USB dongle), using the free VictronConnect software available on the App Store of your device, or www.victronenergy.com.

3.5. Programmable relay

The product is equipped with a programmable relay. The relay can be programmed for different applications, for example as a starter relay.

3.6. Programmable analog/digital input/output ports

The product is equipped with 2 analog/digital input/output ports.

These ports can be used for several purposes. One application is communication with the allow-to-charge and allow-to-discharge BMS controls of a lithium-ion battery.

See appendix.

3.7. Built-in Battery Monitor

The ideal solution when the product is part of a hybrid system (AC input, inverter/chargers, storage battery, and alternative energy). The built-in battery monitor can be set to open and close the relay:

- start at a preset % discharge level
- start (with a preset delay) at a preset battery voltage
- start (with a preset delay) at a preset load level
- stop at a preset battery voltage
- stop (with a preset delay) after the bulk charge phase has been completed
- stop (with a preset delay) at a preset load level

3.8. High efficiency

Outstanding inverter/charger efficiency - Maximum efficiency of 96%. The inverter is short circuit proof and protected against overheating, whether due to overload or high ambient temperature.

Ultra-fast Maximum Power Point Tracking (MPPT) - Especially in case of a clouded sky, when light intensity is changing continuously, a fast MPPT algorithm will improve energy harvest by up to 30% compared to PWM charge controllers and by up to 10% compared to slower MPPT controllers.

Advanced Maximum Power Point Detection in case of partial shading conditions - If partial shading occurs, two or more maximum power points may be present on the power-voltage curve. Conventional MPPTs tend to lock to a local MPP, which may not be the optimum MPP. The innovative SmartSolar algorithm will always maximize energy harvest by locking to the optimum MPP.

3.9. Frequency shift function



This section's information does not apply when the AC input is connected and functioning properly, or when ESS is operating normally. Frequency shifting is not possible with the AC input connected.

Frequency shifting is possible only when the AC input of the Multi RS Solar is disconnected.

When external PV inverters are connected to the AC output of the Multi RS Solar, excess solar energy recharges the batteries. Once battery absorption voltage is reached, the Multi RS Solar automatically increases its output frequency in order to reduce charge power from the PV inverter (no configuration needed). The f_{stop} frequency is 53.2Hz. However, the AC PV inverter might require additional configuration.

This feature is used for battery over charge protection and solar assist.

The Multi RS Solar cannot completely charge the battery to a 100% State of Charge using an AC PV inverter.

This is a safety measure to avoid overcharging the battery when rapid adjustments of the AC PV output are not possible, preventing a system shutdown. As a result, there will always be some capacity left in the battery to absorb any surplus power.

To complete a full charge from solar, connect PV to the internal MPPT solar charger, or another DC coupled MPPT.

3.10. High power inverter

High peak power - The inverter is able to supply a maximum AC output power to a peak 9000W or 50A AC, for 3 seconds. This supports smooth operation for motor start up and other demanding surge loads.

Continuous power output, with solar boost - Continuous output power at 25C ambient, at 52VDC, is 5300W. When combined with solar power from the built-in MPPT this increases approximately 10% to 5800W.

Isolated PV connections for additional safety - Full galvanic isolation between PV and battery connections provide additional overall system safety.

Temperature Protected - Over-temperature protection and power derating when temperature is high.

3.11. Galvanically isolated battery

The battery terminals are galvanically isolated from the PV inputs and the AC terminals.



The PV inputs are NOT galvanically isolated from the AC terminals.

3.12. PV Inverter only mode

The Multi RS Solar can be used as a PV inverter without a battery. The two 3kW MPPT trackers will allow separate PV arrays to feed in directly via the AC input.

3.13. Interfacing and Communications

VE.Direct port and two VE.Can ports

The Multi RS Solar only supports a data connection to a GX device (i.e Cerbo GX) via the VE.Can port, and not the VE.Direct port. The VE.Direct port can be used to connect a GlobalLink 520 for remote data monitoring, or USB to VE.Direct dongle for VictronConnect access on a Windows computer.

Device Display

A 4 line LCD back-lit display shows operational information including battery levels, solar yield, and system icons.

User I/O connector:

- Aux 1, 2 input
- Programmable relay
- Battery voltage sense (Vsense)
- Battery temperature sense (Tsense)
- Remote H & Remote L - Configurable

Bluetooth Smart built-in

The wireless solution to set-up, monitor and update the controller using Apple and Android smartphones, tablets or other compatible devices.

Configuring and monitoring with VictronConnect

Configure with the VictronConnect app. Available for iOS, Android devices, as well as macOS and Windows computers. A VE.Direct to USB accessory is required for Windows systems; enter VictronConnect in the search box on our website and see the VictronConnect download page for details.



3.14. Battery charger

The batteries can be charged by solar energy using the built-in MPPT solar controller, a compatible AC supply connected to the AC input, or an AC PV grid inverter connected to the AC output. The built-in MPPT has a power limit of 6000 W total - 3000 W per tracker. If an additional PV grid inverter is connected (max 5000W), the maximum total charging current is limited to 100A. The maximum charging current of 100A is reduced if battery voltage goes above 60V. A custom maximum charge current value can also be defined by the installer in VictronConnect. If using a PV grid inverter, it will only charge the battery to ~95%.

The charger algorithm is the same as for the BlueSolar MPPT solar controllers. This provides built-in battery preset parameters, and allows for expert mode to define additional charging parameters.

3.14.1. Lead-acid batteries

Adaptive 4-stage charge algorithm: bulk – absorption – float – storage

The microprocessor-driven adaptive battery management system can be adjusted for various types of batteries. The adaptive function automatically adapts the charging process to battery use.

The right amount of charge: variable absorption time

In the event of slight battery discharge, absorption is kept short to prevent overcharging and excessive gas formation. After deep discharging, the absorption time is automatically extended in order to fully charge the battery.

Preventing damage due to excessive gassing: the BatterySafe mode

If, in order to quickly charge a battery, a high charge current in combination with a high absorption voltage has been chosen, damage due to excessive gassing will be prevented by automatically limiting the rate of voltage increase once the gassing voltage has been reached.

Less maintenance and aging when the battery is not in use: the Storage mode

The Storage mode kicks in whenever the battery has not been subjected to discharge during 24 hours. In the Storage mode float voltage is reduced to 2,2V/cell to minimise gassing and corrosion of the positive plates. Once a week the voltage is raised back to

the absorption level to 'equalize' the battery. This feature prevents stratification of the electrolyte and sulphation, a major cause of early battery failure.

Battery voltage sense: the correct charge voltage

Voltage loss due to cable resistance can be compensated by using the voltage sense facility to measure voltage directly on the DC bus or on the battery terminals.

Battery voltage and temperature compensation

The temperature sensor (supplied with the product) serves to reduce charging voltage when battery temperature rises. This is particularly important for maintenance-free batteries, which could otherwise dry out by overcharging.

3.14.2. Li-ion batteries

Victron LiFePO4 Smart batteries

When using Victron Smart lithium batteries, the system will need to be wired using a compatible Victron BMS.

Lynx Smart BMS - This BMS is recommended when also using a GX device in the system. It is connected via the VE.Can bus interface. Note when using this BMS set the Remote Mode to Remote on/off when commissioning the product in VictronConnect.

SmallBMS - This BMS is connected using the allow to charge, and allow to discharge contacts from the Victron smallBMS to the I/O connection port. Note when using this BMS configure for Remote Mode 2-wire BMS when commissioning the product in VictronConnect.

Compatible BMS-Can Lithium Batteries

Compatible BMS-Can lithium batteries can be used with Multi RS Solar however it is a requirement that those batteries to be connected via the BMS-Can port of the GX device (such as the Cerbo GX), and not to the Multi RS Solar communications interface directly. See the [Victron Battery Compatibility Guide for more specific information](#).

3.14.3. More on batteries and battery charging

Our book 'Energy Unlimited' offers further information on batteries and battery charging, and is available free of charge on our website: <https://www.victronenergy.com/support-and-downloads/technical-information>.

For more information on adaptive charging, please also refer to the General Technical Information on our website.

Victron provides a comprehensive Online Training program via the <https://www.victronenergy.com.au/information/training> web portal. Successful completion of this training should be considered essential for system designers and installers, and is recognised with a graduation certificate.

3.15. Setup options

Adaptive three step charging

The Charge Controller is configured for a three step charging process: Bulk – Absorption – Float.

A regular equalization charge can also be programmed.

Bulk- During this stage the controller delivers as much charge current as possible to rapidly recharge the batteries.

Absorption - When the battery voltage reaches the absorption voltage setting, the controller switches to constant voltage mode. When only shallow discharges occur the absorption time is kept short in order to prevent overcharging of the battery. After a deep discharge the absorption time is automatically increased to make sure that the battery is completely recharged.

Additionally, the absorption period is also ended when the charge current decreases to less than 2A.

Float - During this stage, float voltage is applied to the battery to maintain a fully charged state.

Optional external voltage and temperature sensor

Wired connections are available for battery voltage and temperature sensing. The Solar Charger uses these measurements to optimize its charge parameters. The accuracy of the data it transmits will improve battery charging efficiency, and prolong battery life.

The Smart Battery Sense and other VE.Smart networking features are not currently supported.

Remote on-off input

Remote L functions as 'allow to charge' in case lithium battery is selected and remote H functions as 'allow to discharge'. Use smallBMS for the RS with Victron lithium batteries.

Programmable relay

Can be programmed (with a smartphone) to open or close on an alarm, or other events.

3.16. Limitations

Full ESS is not supported

The Multi RS Solar does not yet support all grid codes, and therefore does not yet fully support ESS in all installations. See ESS features topic for more details.

Note: For off-grid operation, and for preventing grid or generator feed in, the ESS mode should be set to "Keep Batteries Charged".

Assistants and advanced controls are not supported

The Multi RS Solar will not support VE.Configure assistants programming. Customisation and controls are currently limited to what is displayed in the Multi RS Solar settings in VictronConnect. You can use the Multi RS Solar demo mode in VictronConnect to see what features are currently available. We expect additional similar control functionality to be added over time.

Parallel units are not supported

The Multi RS Solar does not support synchronising AC output sine waves between parallel units. It is not yet known if the current hardware revision will be able to support parallel configurations via a firmware update in the future.

Maximum charging power limitations

The Multi RS Solar dual tracker can charge the batteries from 3 sources; AC input, DC Solar MPPT, and AC output with AC PV inverter.

- Maximum from AC sources is 88 A DC at 230 VAC and 57.6 VDC, for other voltages see graph below.
- Maximum from DC MPPT tracker is 6kW total, 3kW per tracker for the two tracker model. For the (discontinued) single tracker model, this is 4kW.
- Combined maximum total is 100 A DC

The maximum charge current will vary depending on the battery voltage, and the AC input voltage.

For example, a normal output current variation range is 100A at 48VDC/180VAC to 67A at 60VDC/180VAC.

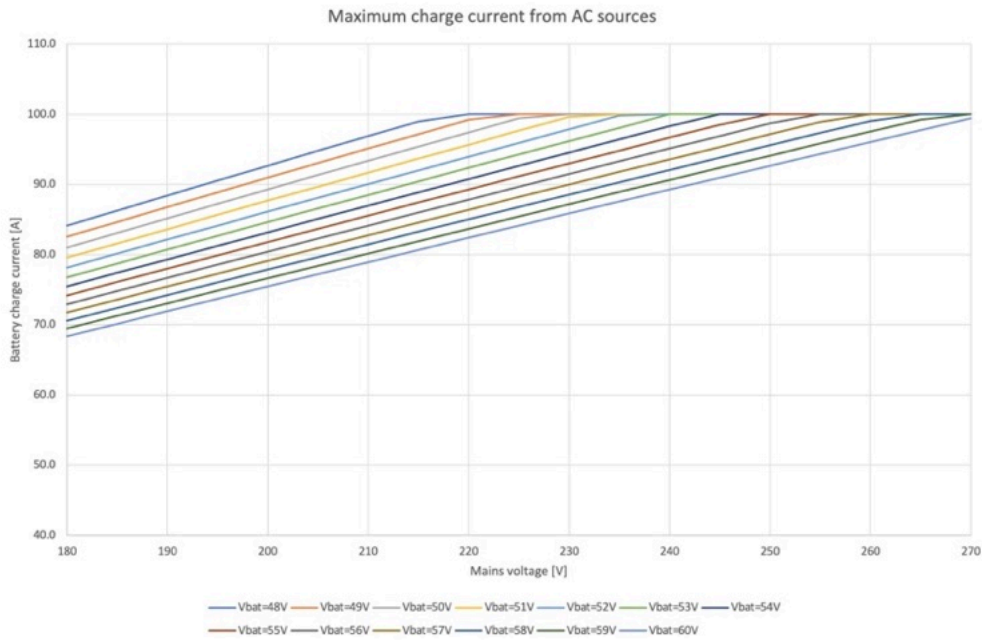







It is normal behaviour that output may reduce below these maximum charge current specifications due to ambient temperature and airflow.

AC2 output is not programmable or relay controlled

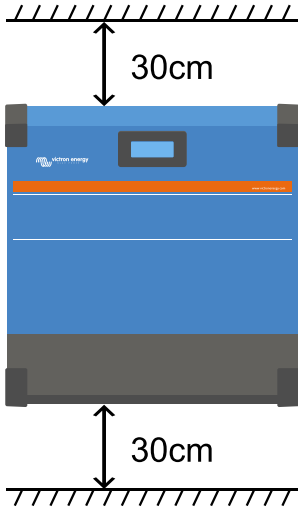
AC2 output is internally hard wired to the AC input. There is no internal relay contact switch that is able to disconnect, or reconnect it via programming. There is also no delay from when the AC input is connected to when it flows through to the AC2 output.

4. Installation

4.1. Location of the Multi RS Solar

 <p>The diagram shows a blue and grey rectangular unit (Multi RS Solar) mounted vertically. Two double-headed arrows indicate a 30cm clearance above the top of the unit and a 30cm clearance below the bottom of the unit. The unit is shown between two horizontal lines representing a ceiling and a floor.</p>	<p>To ensure a trouble free operation of the Multi RS Solar, it must be used in locations that meet the following requirements:</p> <ol style="list-style-type: none"> Avoid any contact with water. Do not expose the product to rain or moisture. Install the Multi RS Solar upright and vertical. Ensure 30cm clearance above and below it. The Multi RS Solar must be installed on a non-flammable surface and the construction materials surrounding the installation should also be non-flammable. Do not place the unit in direct sunlight. Ambient air temperature should be between -40°C and 60°C (humidity $< 95\%$ non-condensing). Do not install the Multi RS Solar in an environment where the air could be contaminated with particulate matter such as soot, dust or salt. For example conductive soot from the exhaust of a diesel generator could be drawn into the unit and cause short circuits inside it. Do not install the Multi RS Solar where flammable or corrosive gases or vapours could come near the installation. Do not obstruct the airflow around the Multi RS Solar. If the Multi RS Solar is installed in an area used for general storage, ensure that no flammable materials such as cardboard boxes are stored close to the installation. Ensure that the end user is aware of these requirements.
	<p>This product contains potentially dangerous voltages. It should only be installed under the supervision of a suitable qualified installer with the appropriate training, and subject to local requirements. Please contact Victron Energy for further information or necessary training.</p>
	<p>Excessively high ambient temperature will result in the following:</p> <ul style="list-style-type: none"> Reduced service life. Reduced charging current. Reduced peak capacity, or shutdown of the inverter. <p>Never position the appliance directly above lead-acid batteries. The unit is suitable for wall mounting. For mounting purposes, a hook and two holes are provided at the back of the casing. The device must be fitted vertically for optimal cooling.</p>
	<p>For safety purposes, this product should be installed in a heat-resistant environment. You should prevent the presence of e.g. chemicals, synthetic components, curtains or other textiles, etc., in the immediate vicinity.</p>
	<p>Never connect batteries directly to the Multi RS Solar without adequate circuit protection.</p> <p>Always ensure that adequate circuit protection is installed between the batteries and the Multi.</p>
	<p>Batteries shall have a flammability class of HB or better.</p>
	<p>Each system requires a method of disconnecting the AC and DC circuits.</p> <p>If the overcurrent protection device is a circuit breaker, it can also serve as the disconnect switch.</p> <p>If fuses are used, separate disconnect switches are required between the source and the fuses.</p>

Try and keep the distance between the product and the battery to a minimum in order to minimise cable voltage losses

4.2. Battery and battery lead requirements

In order to utilize the full capacity of the product, batteries with sufficient capacity and battery cables with sufficient cross section should be used. The use of undersized batteries or battery cables will lead to:

- Reduction in system efficiency.
- Unwanted system alarms or shutdowns.
- Permanent damage to system.

See table for MINIMUM battery and cable requirements.

Battery capacity	Lead acid	200 Ah
	Lithium	50 Ah
Recommended DC fuse	35 mm ² cable	125 A
	70 mm ² cable	200 A
Minimum cross section (mm ²) per + and - connection terminal	0 - 2 m	35 mm ²
	2 - 5 m	70 mm ²



Consult battery manufacture recommendations to ensure the batteries can take the total charge current of the system. Decision on battery sizing should be made in consultation with your system designer.



Use a torque wrench with insulated box spanner in order to avoid shorting the battery.

Maximum torque: 14 Nm

Avoid shorting the battery cables.

To access the battery terminals, undo the two screws at the bottom of the enclosure and remove the cover to expose the service compartment.

- The battery terminals for the Multi RS Solar are located on the left-hand side of the wiring compartment.
- Remove the nut, spring washer, and flat washer before attaching the cable terminal lug.
- **Note:** The bottom nut is soldered to the PCB; do not attempt to loosen it.

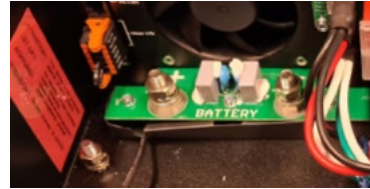

- It is important to place the terminal lug onto the stud first, followed by the flat washer, spring washer, and nut, in that order.
- Ensure that each nut is tightened to a maximum torque of 14 Nm.

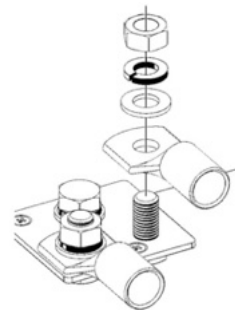

4.3. Solar array configuration

The Multi RS Solar Dual tracker model must keep the individual tracker inputs isolated from each other. That means one solar PV array per input, do not attempt to connect the same array to multiple tracker inputs.



Always use genuine Staubli MC4 connectors for the PV connections to the Multi RS Solar.
Connectors from other brands may not be fully compatible with the Staubli connectors on the Multi RS Solar.

The Multi RS Solar is built using Staubli MC4 connectors. There are many other brands available, but some manufacturing variations mean that they may make poor contact and cause excessive heat. There are also inferior brands on the market which will likely cause problems.



The maximum rated voltage of the solar charger is 450 V. A PV overvoltage event will damage the solar charger. This damage is not covered by warranty.

In case the PV array is located in colder climates the PV array can output more than its rated Voc. Use the [MPPT sizing calculator on the solar charger product page](#) to calculate this variable. As a rule of thumb, keep an additional 10% safety margin.

The maximum operational input current for each tracker is 12 A.

MPPT PV inputs are protected against reverse polarity, to a maximum short circuit current of 16 A for each tracker.



BEWARE that the product warranty will be void if a PV array with a short circuit current larger than 16 A array is connected in reverse polarity.



The Multi RS Solar Dual tracker model must keep the individual tracker inputs isolated from each other. That means one solar PV array per input, do not attempt to connect the same array to multiple tracker inputs.

When the MPPT switches to float stage it reduces battery charge current by increasing the PV Power Point voltage.

The maximum open circuit voltage of the PV array must be less than 8 times the minimum battery voltage when at float.

For example, where a battery has a float voltage of 54.0 volts, the maximum open circuit voltage of the connected array cannot exceed 432 volts.

Where the array voltage exceeds this parameter the system will give a "Over-charge Protection" error and shut down.

To correct this, either increase the battery float voltage, or reduce PV voltage by removing PV panels from the string to bring the voltage back within specification.

4.3.1. Multi RS Solar example PV configuration



This is an example of an array configuration. The decision on the specific array configuration, sizing and design for your system should be made in consultation with your system designer.

Table 1. PV Array Example

Panel Type	Voc	Vmpp	Isc	Impp	# of panels	Max String Voltages	Power total
Victron 260W (60 cell)	36.75 V	30 V	9.30 A	8.66 A	#1 - 8 #2 - 8	304 V	4160 W

4.4. MPPT grounding, detection of PV array insulation faults & Earth fault alarm notification

The Multi RS Solar will test for sufficient resistive isolation between PV+ and GND, and PV- and GND.

In the event of a resistance below the threshold (indicating an earth fault), the inverter shuts down and disables the ac outputs (mppt keeps charging the battery as this has no impact on safety due the isolation to the battery side).

If an audible alarm and/or email notification of this fault is required, then you must also connect a GX device (such as the Cerbo GX). Email notifications require an internet connection to the GX device and a VRM account to be configured.

The positive and negative conductors of the PV array must be isolated from ground.

Ground the frame of the PV array to local requirements. The ground lug on the chassis should be connected to the common earth.

The conductor from the ground lug on the chassis of the unit to earth should have at least the cross-section of the conductors used for the PV array.

When a PV resistance isolation fault is indicated, do not touch any metal parts and immediately contact a suitably qualified technician to inspect the system for faults.

The battery terminals are galvanically isolated from the PV array. This ensures that PV array voltages cannot leak to the battery side of the system in a fault condition.

4.5. Cable connection sequence

First: Confirm correct battery polarity, connect the battery.

Second: if required, connect the remote on-off, and programmable relay, and communications cables

Third: Confirm correct PV polarity, and then connect the solar array (if incorrectly connected with reverse polarity, the PV voltage will drop, the controller will heat up but will not charge the battery).

4.6. Battery connection procedure

Proceed as follows to connect the battery cables:



Use a torque wrench with insulated box spanner in order to avoid shorting the battery. Avoid shorting the battery cables.



Specific care and attention must be taken when making the battery connections. Correct polarity must be confirmed with a multimeter before connection. Connecting a battery with incorrect polarity will destroy the device and is not covered by warranty.

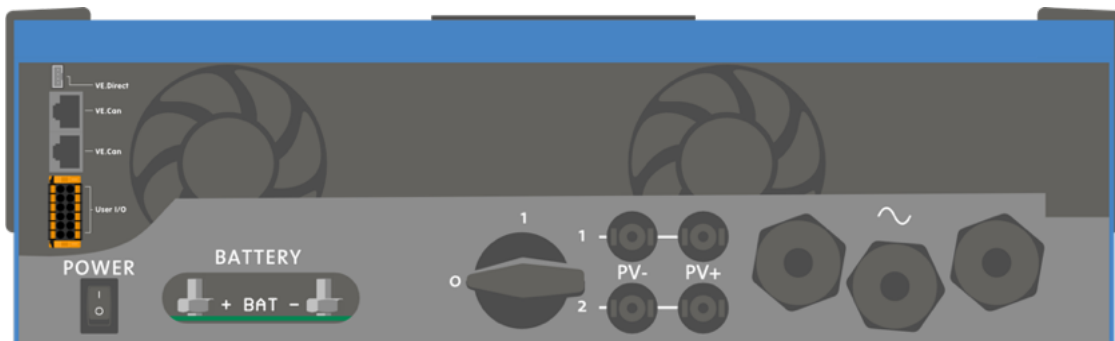

- Undo the two screws at the bottom of the enclosure and remove the service panel.
- Connect the battery cables. First the - cable then the +. Be aware that there may be a spark when making the battery connections.
- Tighten the nuts to the prescribed torques for minimal contact resistance.

4.7. Connection of AC cabling



Always ensure the Multi RS Solar is switched off and the AC input is isolated before removing the wiring compartment cover.



This is a safety class I product (supplied with a ground terminal for safety purposes). **Its AC input and/or output terminals and/or grounding point on the inside of the product must be provided with an uninterruptible grounding point for safety purposes.**

In a fixed installation, an uninterruptible grounding can be secured by means of the grounding wire of the AC input. Otherwise, the casing must be grounded.

This product is provided with a ground relay that **automatically connects the Neutral output to the chassis if no external AC supply is available.** If an external AC supply is provided, the ground relay H will open before the input safety relay closes. This ensures the correct operation of an earth leakage circuit breaker that is connected to the output.

In a mobile installation (for example, with a shore current plug), interrupting the shore connection will simultaneously disconnect the grounding connection. In that case, the casing must be connected to the vehicle chassis.

A fuse or automatic circuit breaker rated to support the expected load must be installed in series with the output, and the cable cross-section must be sized accordingly.



The Multi RS Solar does not provide full galvanic isolation between PV DC input and AC terminals.

In accordance with IEC62109-1 and IEC62109-2, an internal Residual Current Monitoring Unit (RCMU) ensures that no DC current appears on the AC side. Both DC and AC fault current component types are monitored. If a fault is detected, the inverter will be automatically shut down, disconnecting the AC system.

Ensure that your AC installation meets local regulations for residual current protection. Please refer to the [RCD Information on Multi RS](#) document for further guidance.



Full galvanic isolation is provided between AC and battery DC.

The AC connection terminal blocks can be found on the right hand side of the wiring compartment.

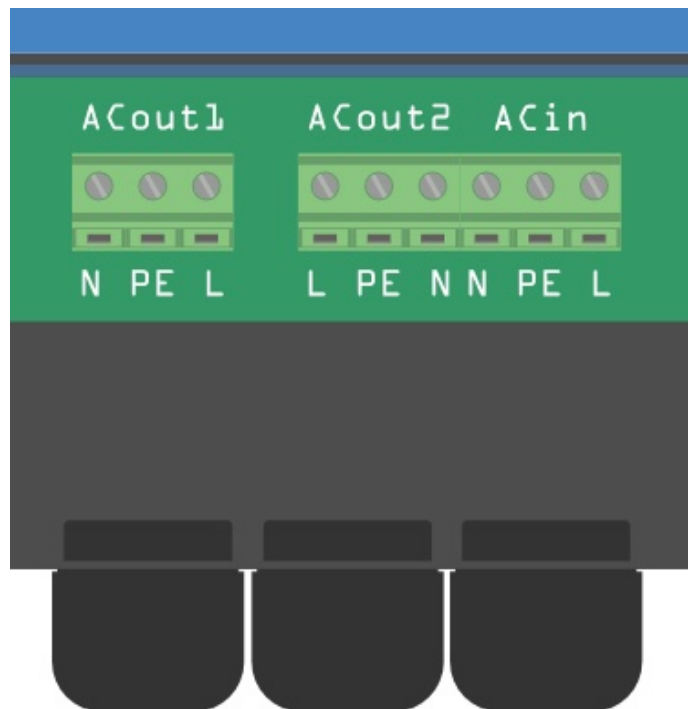

The AC connector blocks are the screw clamp type.



Conductor insulation should be stripped to expose 10 mm of bare conductor.
Maximum tightening torque is 1.2 Nm.



DO NOT reverse the polarity of the neutral and line conductors when connecting AC cabling.

- **AC-out-1** The AC output cable can be connected directly to the terminal block 'AC-out'. From left to right: "N" (neutral) - "PE" (earth) - "L" (phase). With its PowerAssist feature the Multi can add up to 6kVA (that is $6000 / 230 = 26A$) to the output during periods of peak power requirement. The Multi RS can provide throughput of up to 50 A to the loads. The AC input relays are limited to 50 A (Multi RS - 2 tracker), and the inverter can contribute up to 25 A continuous at best conditions (when it gets hotter this figure will be reduced).



The AC output terminals must be protected from overload by a fuse or circuit breaker rated at 50 A or less, and cable cross-section must be sized accordingly.

- **AC-out-2** A second output is available that disconnects its load in the event of battery-only operation. On these terminals, equipment is connected that may only operate if AC voltage is available on AC-in-1, e.g. an electric boiler or an air conditioner. The load on AC-out-2 is disconnected immediately when the inverter/charger switches to battery operation. After AC power becomes available on AC-in-1, the load on AC-out-2 will also be reconnected immediately.
- **AC-in** The AC input cable can be connected to the terminal block 'AC-in'. From left to right: "N" (neutral) - "PE" (earth) - "L" (line). **The AC input must be protected from overload by a fuse or magnetic circuit breaker rated at 50 A or less, and cable cross-section must be sized accordingly.** If the input AC supply is rated at a lower value, the fuse or magnetic circuit breaker should be down sized accordingly.

4.8. VE.Direct

This can be used to connect a PC/laptop to configure the inverter with a VE.Direct to USB accessory. Can also be used to connect a Victron GlobalLink 520 to allow for remote data monitoring.



The VE.Direct port on the Multi RS Solar cannot be used to connect to a GX device, and the VE.Can connection must be used instead.

4.9. VE.Can

The VE.Can ports can be used to connect to other devices, such as:

- A GX device for monitoring and communication.
- Other Multi RS Solar devices forming a three phase system.
- An energy meter such as the Victron VM-3P75CT.
- Additional MPPT's like the MPPT RS or other VE.Can MPPT controllers.



VE.Can terminators should always be installed in the devices at both ends of the VE.Can network.

4.10. Bluetooth

Used to connect to the device via VictronConnect for configuration.

Note that this Bluetooth interface is not compatible with VE.Smart Networking (i.e Smart Battery Sense).

4.11. User I/O

The user I/O terminal block is located on the left hand side inside the wiring compartment.

The terminal block can be removed to make connecting small wires easier. To release it, push both orange levers (top and bottom of the connector) to the left.

Connections are made by pushing the wire into the hole. In the "TOP" orientation, the wire can be released by pushing down the orange tab next to the hole with a small flat blade screwdriver.



From the factory, there is a wire link installed in the Remote_H and Remote_L position. This will enable the Multi RS Solar to operate by default. If this wire link, or the connector is removed then the Remote_H and Remote_L terminals become open circuit, and the Multi RS Solar will not turn on.

The diagram below shows the pinout of the connector and the function of each pin. The functions are also printed on the side of the connector itself.

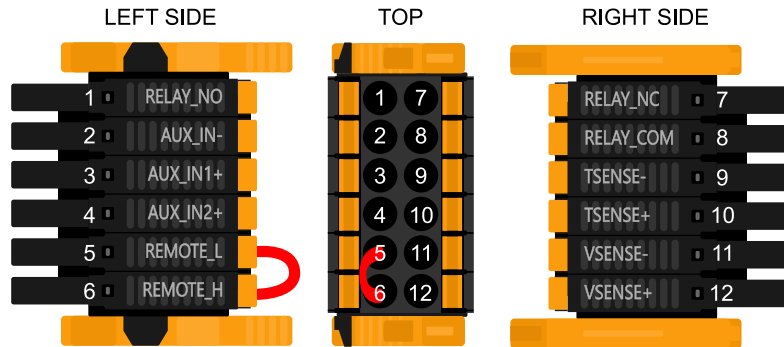

Pin number	Pin name	Description
1	Relay_NO	Programmable relay Normally Open connection
2	AUX_IN-	Common negative for programmable auxiliary inputs
3	AUX_IN1+	Programmable auxiliary input 1 positive connection
4	AUX_IN2+	Programmable auxiliary input 2 positive connection
5	REMOTE_L	Remote on/off connector Low
6	REMOTE_H	Remote on/off connector High
7	RELAY_NC	Programmable relay Normally Closed connection
8	RELAY_COM	Programmable relay Common
9	TSENSE-	Temperature Sensor negative
10	TSENSE+	Temperature Sensor positive
11	VSENSE-	Voltage Sensor negative
12	VSENSE+	Voltage Sensor positive

4.11.1. Remote H and L terminals

There are two terminals marked REMOTE_H and REMOTE_L.

The default function of these terminals is to switch the Multi RS Solar on or off remotely.



From the factory, these two terminals are connected together with wire link. This enables the Multi RS Solar to turn on when its main physical switch is on .

To use the terminals for remote connections, the wire link should be removed.

These two contacts can be configured for either remote on/off (default), or for 2-wire BMS mode.

When multiple units are combined in a system — for example in a three-phase setup — you can connect the contact wires to any single unit. The contact's state is then shared with the rest of the system through the VE.Can connections.

You only need to configure the unit which has the contact wires connected to it.

Remote on/off functionality:

The factory fitted wire link can be removed and then wires can be connected to an external switch contact. The switch contact can then be used to switch the Multi RS Solar on or off.

This is the default configuration in VictronConnect, no configuration changes are necessary on a new unit. The configuration can be checked in [Remote mode \[43\]](#) in the Battery settings menu.

The Multi RS Solar will be switched on if the inputs are wired in one of the four ways pictured on the right.

- The factory wire link is in place,
- A closed switch contact is wired between REMOTE_H and REMOTE_L.
- REMOTE_H is wired to battery positive (+48V).
- REMOTE_L is wired to battery negative.

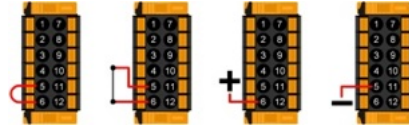

The Multi RS Solar will be switched off if the inputs are wired in one of the four ways pictured on the right.

- The factory wire link is removed and REMOTE_H and REMOTE_L are open circuit.
- An open switch contact is wired between REMOTE_H and REMOTE_L meaning that they are open circuit.
- REMOTE_H is wired to battery negative.
- REMOTE_L is wired to battery positive (+48V).

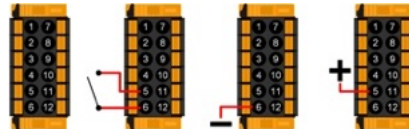
**2-wire BMS mode:**

The REMOTE_H and REMOTE_L terminals can also be configured for interfacing with a 2-wire BMS. Two separate contacts on the BMS control whether the Multi RS Solar is allowed to charge or discharge. This is configured in VictronConnect, see [Remote mode \[43\]](#) in the Battery settings menu.

- Change the mode from "Remote on/off" to "2-wire BMS".

The diagrams below demonstrate what mode the Multi RS Solar will be in depending upon the state of the REMOTE_H and REMOTE_L terminals.



In 2-wire BMS mode, if the REMOTE_H and REMOTE_L terminals are linked (and not connected to +48V), the Multi RS Solar will be on, but charging will be disabled.

The BMS' "Allow to charge" and "Allow to discharge" contacts are both closed.

The REMOTE_H and REMOTE_L terminals are both pulled up to +48V through the BMS switch contacts.

The Multi RS Solar operates normally, and is allowed to charge and discharge the battery.

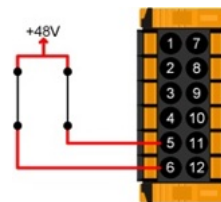

The BMS has opened its "Allow to charge" contact.

The REMOTE_H is pulled up to +48V through the BMS contact and REMOTE_L terminal is open circuit (floating).

The Multi RS Solar stops charging the battery from AC and/or solar sources, but continues to discharge the battery as normal.

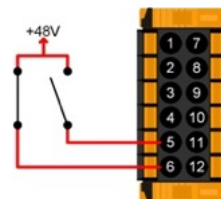

The BMS has opened its "Allow to discharge" contact.

The REMOTE_L is pulled up to +48V through the BMS contact and REMOTE_H terminal is open circuit (floating).

The Multi RS Solar stops discharging the battery, but continues to charge the battery from AC and/or solar sources if available.

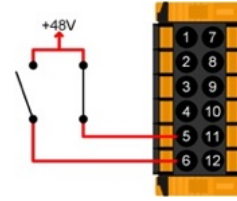

The BMS' "Allow to charge" and "Allow to discharge" contacts are both open.

The REMOTE_H and REMOTE_L terminals are both open circuit (floating).

Neither charging nor discharging is allowed, so the Multi RS Solar switches off.

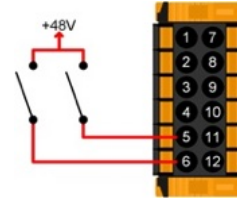

4.11.2. Programmable relay

There is one general-purpose, potential free (dry) relay contact which can be configured for various functions.

Use the [Relay menu \[50\]](#) in VictronConnect to configure it.

The relay contacts are rated for 4A up to 35VDC and 1A at 70VDC.



Do not use the relay contact for any AC (230V) circuits.

In this example, the normally open relay contact is configured for starting and stopping a generator.

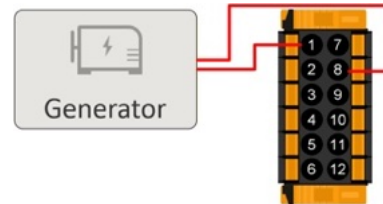

4.11.3. Voltage sense

To compensate for possible cable losses during charging, two sense wires can be connected directly to the battery or to the positive and negative distribution points. Use wire with a cross-section of 0,75mm². During battery charging, the charger will compensate the voltage drop over the DC cables up to a maximum of 1 Volt (i.e. 1V over the positive connection and 1V over the negative connection). If the voltage drop threatens to become larger than 1V, the charging current is limited in such a way that the voltage drop remains limited to 1V.

An example of the VSENSE+ and VSENSE- terminals connected to the battery terminals.

A fuse close to the battery is recommended to protect the Voltage sense wires from any short circuits.

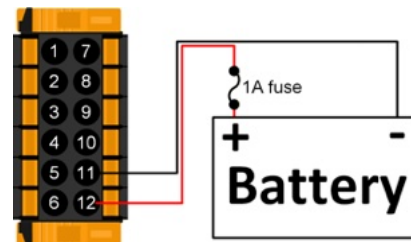

4.11.4. Temperature sensor

For temperature-compensated charging, the temperature sensor (supplied with the unit) can be connected. The sensor is isolated and must be fitted to the negative terminal of the battery. The temperature sensor can also be used for low temperature cut-off when charging lithium batteries. You can configure this in the [Battery settings \[43\]](#) page in VictronConnect.

The supplied battery temperature sensor is connected to the battery negative terminal.



Only use the temperature sensor which is supplied with the Multi RS Solar.

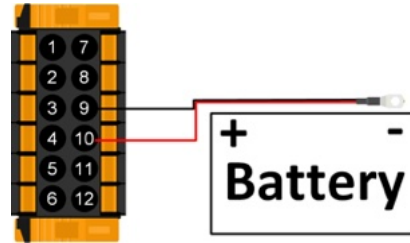

4.11.5. Auxiliary inputs

The Multi RS Solar is equipped with 2 digital input ports, they are labelled AUX_IN1+ and AUX_IN2+ on the removable terminal block, with AUX_IN- being the common terminal for both.

An AUX_IN+ input is considered active when it is connected to AUX_IN-.



Do not connect any of the AUX_IN terminals to the battery positive or negative.

The diagram on the right shows AUX_IN1 as **active**.

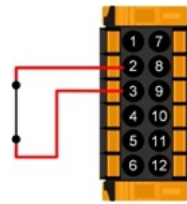

The diagram on the right shows AUX_IN1 as **inactive**.

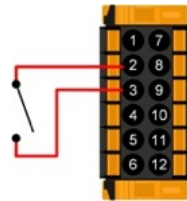

In VictronConnect, the [Aux input settings page \[53\]](#) allows different functions to be configured.

- **Unused:** The Aux input has no function.
- **AC IN connect:** The AC input can be connected or disconnected as needed. For example, you can disable the AC input during expensive peak periods of a time-of-use tariff. Either an active signal or an inactive signal can be used to set the AC input connected state.
- **AC IN feed-in enable:** In a grid parallel installation, the Aux input can be used to enable or disable grid feed-in. Either an active signal or an inactive signal can be used to set the feed-in state.
- **Safety switch:** The Multi RS Solar only operates when the Aux input is active.

This can be used to remotely switch off the Multi RS Solar if the REMOTE_L and REMOTE_H terminals are configured for a 2-wire BMS.

It could also be used as a separate safety switch signal from another system which needs its own input.



If the REMOTE_L and REMOTE_H terminals are in a state that switches the Multi RS Solar off, then this will override the Aux input Safety switch function, and it will remain off.

For example, if the REMOTE_H and REMOTE_L terminals are open circuit, then the Multi RS Solar will be switched off regardless of the state of the Aux input Safety switch

If the same function is assigned to both aux inputs then they will be treated as an AND function, so both will need to active for the function to be recognized as active.



Some grid codes require the auxiliary inputs to be used for charge power limiting or to prevent export. Any grid code functions will override functions defined in the Aux input settings and they will be greyed out.

4.12. Generator programming

The Multi RS Solar has a tolerance for irregularities on the AC input like fast frequency changes or voltage changes to improve reliability when connecting to generators.

Using a generator with the Multi requires firmware version v1.11 or later.

Set the following option on the General settings page:

- Set the "AC input type" to "Generator".
- "Moderate generator load changes" should be switched on.
- Ensure that "Energy meter support" is switched off.
- Adjust the input current limit to suit the power output of the generator.



If no grid code is set then set the following:

- Check that the "Grid code" is "None".
- Switch the "UPS function" off.

The 'UPS function' restricts the acceptance of an AC input to a very precise sine wave so that in the event of an interruption in the AC supply it is possible to maintain an apparent continuity of supply to the loads. This is incompatible with most generators and should be disabled when using a generator to improve reliable acceptance of the AC supply.

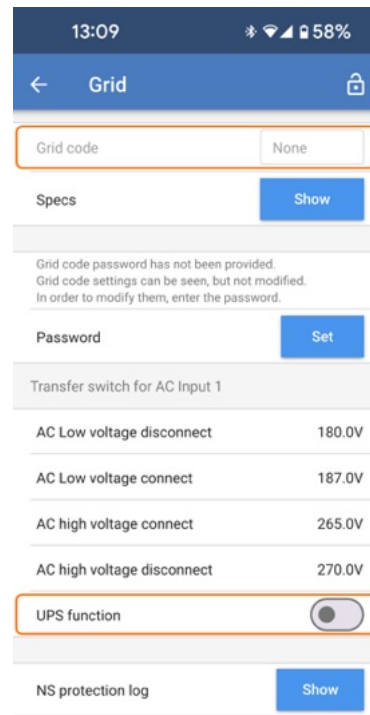

If a grid code is set then set the following two parameters:

- The AC Input 1 LOM detection should be set to "no LOM detection (not compliant)".



Do not disable LOM detection when the Multi RS Solar is connected to the grid.
This option is only to be used when a generator is connected at the AC input.

- Disable feed-in by switching the "Feed-in allowed" option off.

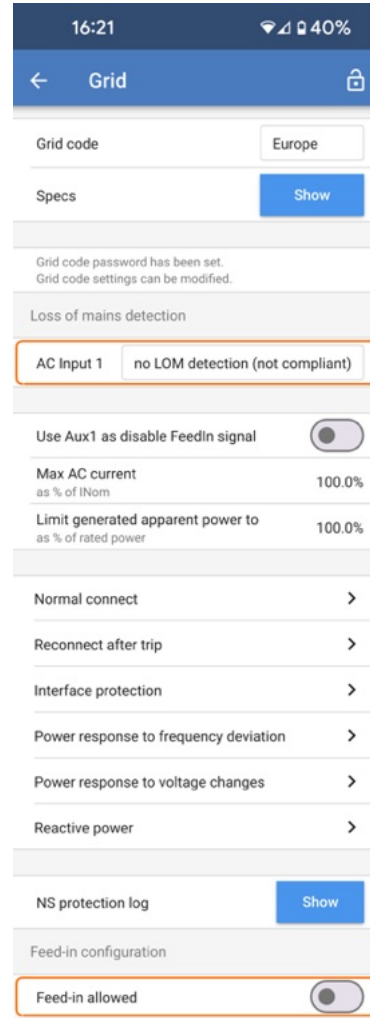

Ensure that the ESS mode is set to "Keep batteries charged".

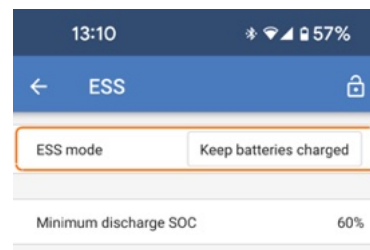

The programmable relay contact of the Multi RS Solar can be used to start and stop a generator. The setup is explained in the [VictronConnect \[50\]](#) section.

The relay contacts are presented on the [User I/O connector \[17\]](#).

See [Limitations \[8\]](#) chapter for additional charging power limitations.

4.13. ESS - Energy Storage System



This information pertains specifically to the 'Dual Tracker' model (PMR482602020).

Grid feed-in using an Energy Storage System is not supported by the older 'Single Tracker' model (PMR482602000).

An Energy Storage System (ESS) is a specific type of power system that uses the Multi RS Solar to work in conjunction with a grid connection. It is used to optimise the use of solar power, battery storage and grid import or export.

ESS can be configured to optimize self-consumption or to keep batteries charged.

When there is more PV power than is required to run loads, the excess PV energy is stored in the battery. That stored energy is then used to power the loads at times when there is a shortage of PV power. When the battery is full, then the excess PV energy can be exported to the grid.

You can choose how much battery capacity you want to keep in reserve. If your grid connection is reliable, you can use more of the battery and keep less in reserve. Conversely, if your grid connection is unreliable and experiences frequent outages, you may prefer to keep more battery energy in reserve.

The "Keep batteries charged" option keeps the batteries fully charged whenever possible. The batteries will only discharge during a grid outage when solar power is insufficient. As soon as grid power returns or sufficient solar power is available, the batteries will recharge automatically.



Do not apply ESS settings in systems with a generator. See the [Generator programming \[19\]](#) section when a generator is connected at the AC input.

The Multi RS Solar can be configured as an Energy Storage System. In this setup, the device functions in grid-parallel mode, allowing energy to be sent back to the grid through the AC input terminals.



For the Multi RS Solar all ESS settings are configured in VictronConnect. There are limited configuration options in the ESS menu of a GX device.

To feed into the grid, you must select the appropriate grid code for your country within VictronConnect. In most cases, permission from the grid operator will be required before configuring an Energy Storage System to feed in.

If you do not have permission from your grid operator or if the installation does not meet the requirements for grid feed-in, set the grid code to 'None.' In this case, energy will not be fed back into the grid.



Grid feed-in certification varies by country for the Multi RS Solar, and it is not currently certified in all countries.

Do not assume the Multi RS Solar is certified or permitted for grid export in your country simply because its grid code is listed in the drop-down.

Always check for current certificates for this product. These are available in the [Downloads & Support](#) section of the website.

Use VictronConnect to configure the Multi RS Solar for ESS as below:

From the main settings page select the ESS settings page.

- **ESS mode:** Tapping the box will display a selection of ESS modes. For an energy storage system, one of the optimized modes is typically the best choice. In this example, "Optimized without battery life" may be most suitable for lithium battery chemistry.

For more information on the other available ESS modes, visit the [VictronConnect \[57\]](#) section.

- **Minimum discharge SOC:** This setting determines the lowest point at which the battery will be discharged when the grid is available. If the grid goes offline, the battery may continue to discharge below this level in order to keep the AC output powered.
- **Self-consumption from battery:** You can choose whether the energy from the battery will power just the critical loads at the AC-out terminals or to also include loads positioned between a grid energy meter and the AC-in terminals.



This option will only be visible if "Energy meter support" is enabled.

Without a grid energy meter, ESS can only supply the critical loads with battery power.

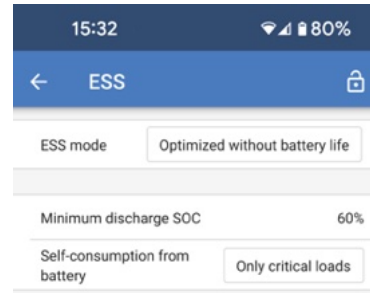

Self-consumption from battery options:

- **All system loads:** ESS will use battery power to supply loads which are connected between a grid energy meter and the AC-in terminals, as well as critical loads connected to the AC-out terminals.
- **Only critical loads:** ESS will only supply battery power to the critical loads connected to the AC-out terminals.

Loads connected between a grid energy meter and the AC-in terminals will be supplied by the grid and not from the battery.

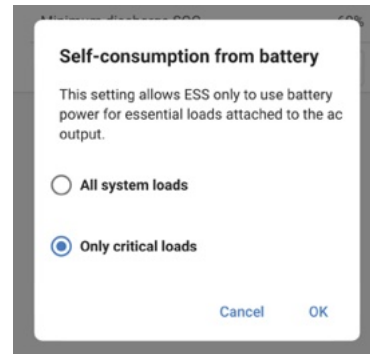

Grid code settings require a password for protection against unauthorized interference.

After setting a grid code for the first time, it cannot be deactivated or modified without a password. If you need assistance changing your grid code, please contact your installer.

Navigate to the Grid settings page, choose an appropriate grid code for your area, and select it. Depending on your selection, additional options may become available, which may vary by region. In this example, we will use Germany as the selected grid code.

Certain settings will appear greyed out and cannot be modified without setting the grid code password. Beware not to alter these settings unless instructed by your grid operator.

- **Grid code:** Choose the country or region that corresponds to your installation's location.



Always check that the Multi RS Solar is certified for use in your country. The drop-down list does not imply certification. Check for certificates [here](#).

- **Specs** Tapping 'Show' displays the details and requirements related to the selected grid code.
- **Password:** Installers have the ability to make additional changes and alter the grid code region by entering the password, but it's essential that you only modify settings as directed by your grid operator.

Loss of mains detection: Most of these settings are typically greyed out and are intended for informational purposes only. The values are defined by the selected grid code.

- **Use Aux1 as disable FeedIn signal:** A grid operator may require a means to disable feed-in. To accommodate this requirement, installers can wire a contact to Aux1 of the Multi RS Solar to disable feed-in as needed.
- **Use Aux2 as limit charger signal:** When using the Germany grid code, there might be a requirement from the grid operator to limit the charging power to 4.2kW divided evenly over the number of units. To meet this requirement, you can wire a contact to Aux2.
- **NS Protection log:** The network system protection log records the five most recent protection events. Tap "Show" to view any logged events.

Feed-in configuration.

- **Feed-in allowed:** This feature is designed to enable or disable excess energy flow into the grid, depending on your location's specific requirements. By default, it is set to 'on' (energy can be fed in), but if feed-in is not allowed, it should be toggled off.
- **Limit system feed-in:** If you have a limit on the amount of energy that can be fed back into the grid, use this feature to set the maximum allowed feed-in power.
- **Maximum feed-in:** Set a maximum limit for the amount of energy that can be fed back into the grid through this device.
- **Feed-in not active:** Use this feature for diagnostic purposes when you notice that energy is not being fed back into the grid. Tapping the 'Check reason' button will display a list of potential reasons for the problem.

The screenshot shows the 'Grid' settings page on a mobile device. At the top, the time is 14:33 and the battery is at 100%. The page title is 'Grid' with a back arrow and a lock icon. The settings are as follows:

- Grid code:** Germany
- Specs:** Show (button)
- Password:** Set (button)
- Loss of mains detection:** LOM (compliant)
- AC Input 1:** LOM (compliant)
- Over voltage U> (10 min. running mean):** 253.0V
- Use Aux1 as disable FeedIn signal:** Toggle off
- Use Aux2 as limit charger signal:** Toggle off
- Start freq f> Over frequency power response:** 50.20Hz
- Droop f> Over frequency power response:** 5.00%
- Max AC current as % of INom:** 100.0%
- NS protection log:** Show (button)
- Feed-in configuration:**
 - Feed-in allowed:** Toggle on
 - Limit system feed-in:** Toggle on
 - Maximum feed-in:** 1000W
 - Feed-in not active:** Check reason (button)

If the grid code requires external control of charging power or to disable grid feed-in, the contacts can be wired to the Aux_IN terminals of the User I/O connector.

Three-phase systems require contact wiring to only one unit's I/O connector. The contact state is then shared with and replicated by all other units in the system.



Not all grid codes support the use of Aux inputs.

As an example, for the German grid code, the Aux_IN terminals are used as below:

- Contact **A** is wired to Aux_IN1+. When the external contact is closed, grid feed-in will be disabled.
- Contact **B** is wired to Aux_IN2+. When the external contact is closed, the charging power from the grid will be limited to 4.2kW.

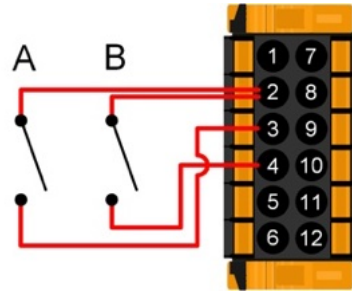

4.14. Connecting to external AC PV inverters

The Multi RS Solar includes a built in AC PV inverter detection system. When there is a feedback of AC PV (a surplus) from the AC-out connection port, the Multi RS Solar will automatically enable an AC output frequency adjustment.

While no further configuration is required, it is important that the AC PV inverter is configured correctly to respond to the frequency adjustment by reducing its output.

Note the 1:1 rule of AC PV inverter size to Multi RS Solar size, and minimum battery sizing applies. More information about these limitations are available in the [AC Coupling manual](#), and this document is required reading if using an AC PV inverter.

The frequency adjustment range is not configurable, and includes a built in safety margin. Once the absorption voltage is reached, the frequency will increase. So it is still essential to include a DC PV component in the system for complete battery charging (i.e. float stage).

The PV inverter stop frequency (f_{stop}) is 53.2Hz. This is not configurable.

It may be possible to adjust the power output response to various frequencies on your AC PV inverter.

The default configuration has been tested and works reliably with the Fronius MG50/60 grid code configuration.

4.15. PV Inverter configuration

The Multi RS Solar can be configured as a PV Inverter without the need for a battery bank. All PV energy will feed in to the grid through the AC input connection.



To use this feature, your system will need to be grid-connected. You'll need to set a suitable grid code for your location and have the necessary permissions to sell power back to the grid.



Do not connect any loads or external PV inverters to the AC output 1.

Set a grid code for your region. See the [Grid settings \[42\]](#) page for more information.

Set the following option on the ESS settings page:

- Set the ESS mode to "PV Inverter only (without batteries)".

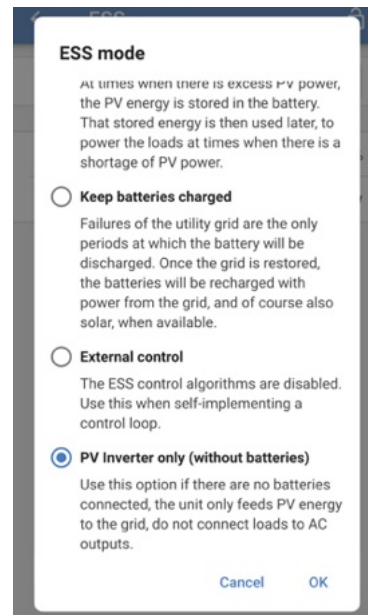

After setting "PV Inverter only mode (without batteries)", the following settings will be enforced:

- System -> System configuration = Standalone
- General -> Energy meter support = Disabled
- AC input control -> Conditional AC input connection = Disabled

4.16. Connecting an external energy meter

The Victron VM-3P75CT energy meter can be used with the Multi RS Solar.

The Victron energy meter can be connected using either VE.Can or Ethernet. A GX device is required for Ethernet connectivity. See example diagrams below.



For Ethernet connectivity, the Multi RS Solar must have firmware version 1.26 or above installed.

The GX device must be running version 3.65 or above.



Any Wi-Fi network segments between the energy meter and the GX device should be avoided due to latency issues.

Use wired Ethernet connections between the energy meter, router/switch, and GX device.

See the VM-3P75CT [manual](#) for full details.

The energy meter can be configured for single phase or three phase systems.

Once the role is selected in the energy meter settings, then energy meter support can be set in the Multi settings:

- **Energy meter support:** Toggle this switch on to enable a grid energy meter to be used in this system. This will allow loads between the grid energy meter and the AC-input terminals of the Multi RS Solar to be supplied by the Multi RS Solar.



The energy meter role needs to be configured as a "Grid" meter.

- **AC current limit at energy meter:** This value will set the maximum current limit at the point that the energy meter is installed. Loads between the energy meter and the Multi RS Solar will be supplied by the grid until the set limit is reached. After this, the Multi RS Solar will begin to "power assist" in order to maintain the set current limit.
- **Current limit at AC input:** This setting determines the maximum current allowed at the AC input terminals of the Multi RS Solar. It limits the AC current for loads on AC out 1 and battery charging. Loads on AC Out 1 will continue to be supplied by AC input, but if the current limit is reached, the Multi RS Solar begins to "power-assist" using energy from the battery.
- **Current limit overruled by remote:** Enable this option to allow the current limit to be adjusted remotely. For example, a GX device can be used to adjust the current limit remotely.

It is not possible to remotely set the current limit any higher than the level defined here.

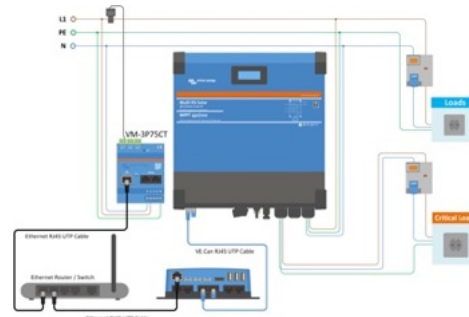
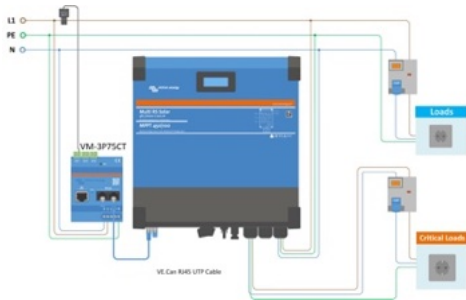
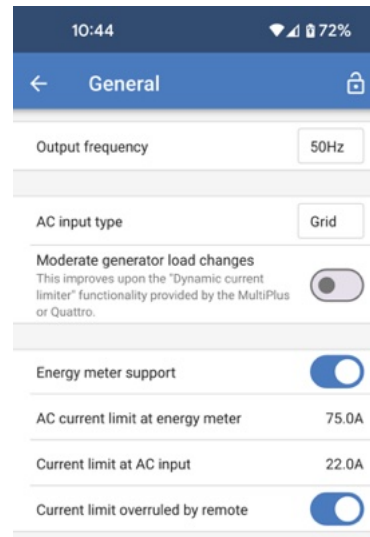

The above wiring example can be used when the energy meter role is set up as "Grid meter" or "Generator". The incoming current from the AC grid or a generator is measured before the AC input of the Multi, or any non-critical AC loads.

If "Energy meter support" is enabled, a current limit can be set at the energy meter to prevent excessive load on a weak AC grid. If the non-critical loads exceed the current limit at the energy meter then the Multi will begin to "power assist" to try and maintain the current limit at or below the set point.

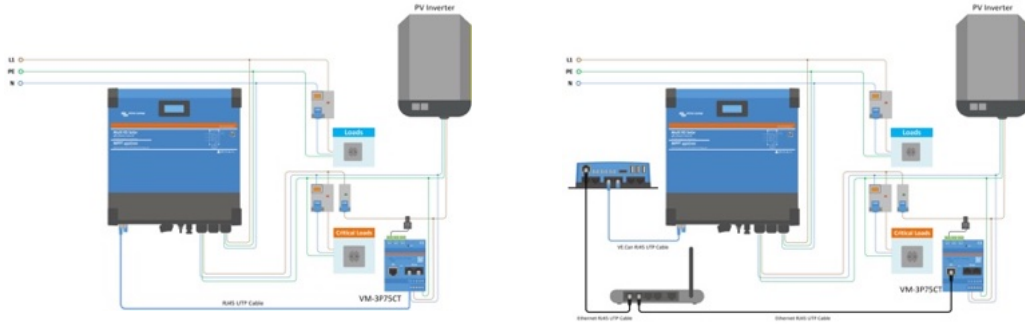

If a generic PV inverter is connected to the AC output of the Multi the energy meter role should be set to "PV Inverter" and wired to measure the current produced by the PV inverter.

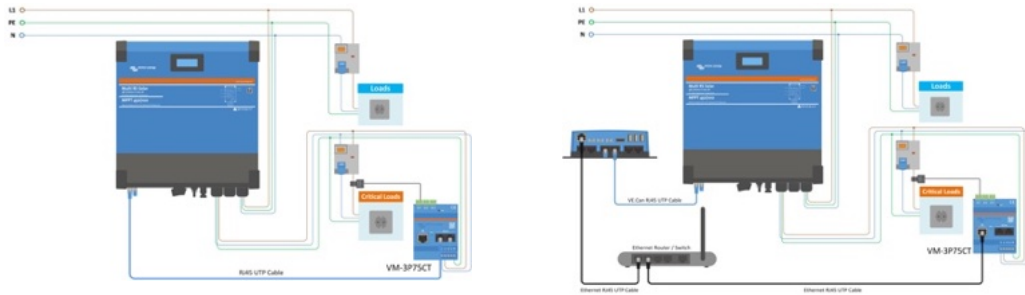

When the energy meter role is set to "AC load" then the energy meter can be wired to measure specific loads. For example, a water heater circuit could be measured to monitor its power consumption and also track the amount of energy it uses.

4.17. Large systems - 3 phase



3 phase systems are complex. We do not support or recommend that untrained and/or inexperienced installers work on these size systems.

If you are new to Victron, please start with small system designs, so that you become familiar with the necessary training, equipment and software required.

It is also recommended to hire an installer that has experience with these more complex Victron systems, for both the design and the commissioning.

Victron is able to provide specific training for these systems to distributors via their regional sales manager.



VE.Can 3 phase networking differs from VE.Bus. Please read the documentation in full, even if you have experience with large VE.Bus systems.

Mixing different models of Inverter RS (ie. the model with Solar and without Solar) is possible. However mixing Inverter RS with Multi RS is not currently supported.

DC and AC wiring

Each unit needs to be fused individually on the AC and DC side. Make sure to use the same type of fuse on each unit.

The complete system must be wired to a single battery bank. We do not currently support multiple different battery banks for one connected 3 phase system.

Communication wiring

All units must be daisy chained with a VE.Can cable (RJ45 cat5, cat5e, or cat6). The sequence for this is not important.

Terminators must be used at both ends of the VE.Can network.

The temperature sensor can be wired to any unit in the system. For a large battery bank it is possible to wire multiple temperature sensors. The system will use the one with the highest temperature to determine the temperature compensation.

Programming

Settings need to be set manually by changing the settings in each device. However, some of the settings related to three phase operation can be propagated to other units with [System settings sync \[59\]](#).

Charger settings (voltage and current limits) are overridden if DVCC is configured and if a BMS-Can BMS is active in the system.

System Monitoring

It is strongly recommended that a [GX Family Product](#) is used in conjunction with these larger systems. They provide highly valuable information on the history and performance of the system.

System notifications are clearly presented and many additional functions are enabled. Data from [VRM](#) will greatly speed support if it is required.

4.18. 3 phase installation

The Multi RS Solar supports single phase, and three phase configurations. It does not currently support split phase.

The factory default is for stand alone, single unit operation.

If you wish to program for three phase operation, it requires at least 3 units.

The maximum supported system size is 3 units in total, with a single unit on each phase.

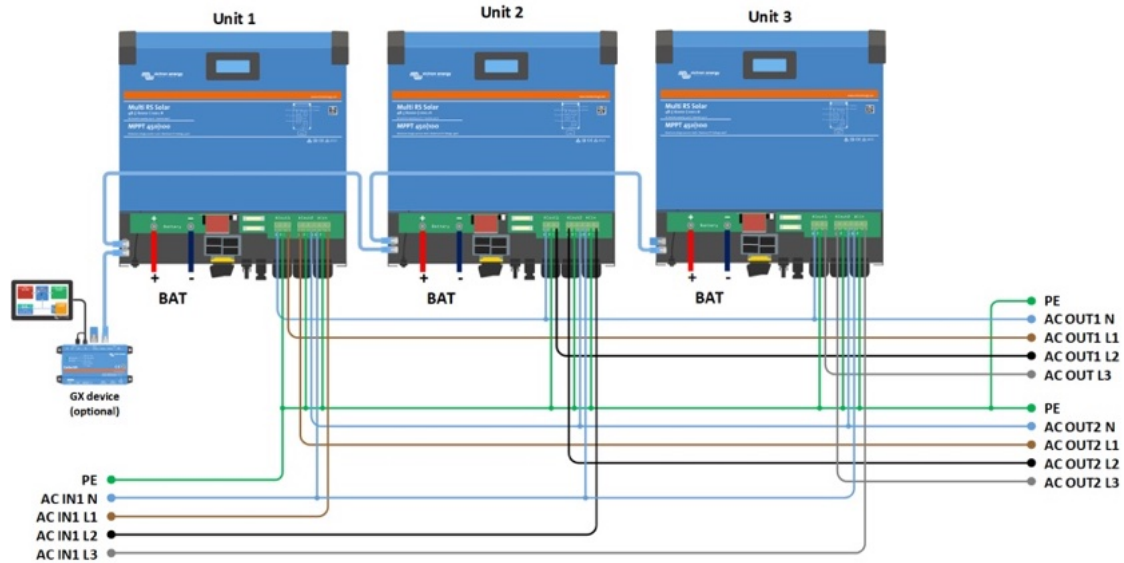

They must be connected to each other via VE.Can connections, with a VE.Can terminator at the start and the end of the bus.

Once the units are connected to the battery and via VE.Can they will need to be configured.

Delta configurations not supported

For units in 3 phase configuration: Our products have been designed for a star (Y) type three phase configuration. In a star configuration all neutrals are connected, a so called: "distributed neutral".

We do not support a delta (Δ) configuration. A delta configuration does not have a distributed neutral and will lead to certain inverter features not operating as expected.

4.19. 3 phase programming

In order to configure a 3 phase system the Multi RS Solar will need to be **correctly installed**, and running firmware version v1.13 or later.

Configuring a system for three phase or single phase is done in VictronConnect in the System menu.



AC output power will be disconnected for a few seconds when switching System configuration modes. Make sure the system is configured BEFORE connecting inverter AC output to the loads.



These System settings must be programmed individually, and set correctly on all connected units for synchronised operation.

The factory default System configuration setting is "Standalone".

Tap the box to bring up a popup menu where you can select "Three phase". There are two three phase options to choose from, either clockwise or counter clockwise, depending upon the phase rotation at the installation site.

You'll need to apply these same settings to each unit individually.

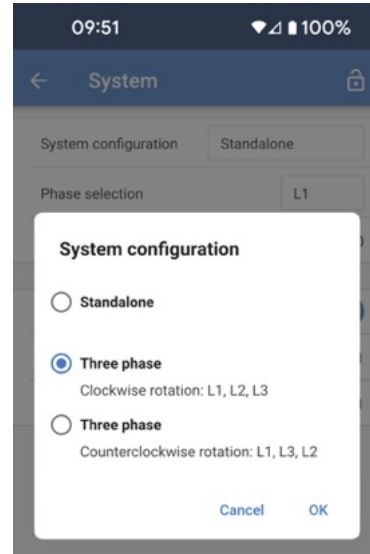

Select the correct phase that each particular unit is connected to. There can only be one unit per phase.

Do this for each individual unit.

It is also advisable to physically label each unit and also give a matching custom name in the product info settings.

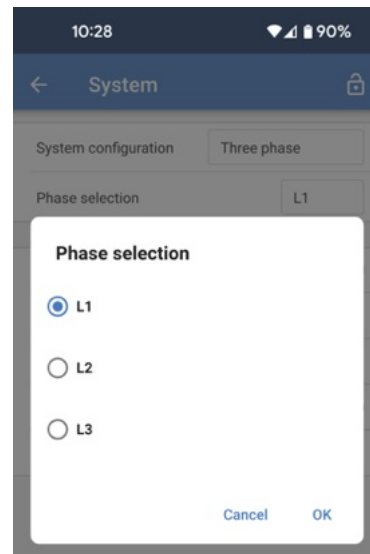

- **System instance:** Units with the same instance number work together on the AC side.

Changing the System instance setting allows multiple groups of Inverters to be on the same VE.Can bus, but not synchronised, and segmented into different AC outputs, without interference.

Continue with the same programming settings on the rest of the units.

- **System settings sync:** This option allows synchronization of certain settings amongst units in the system.

There is more about it [here \[59\]](#).

- **Prevent CAN network islanding:** This setting determines what the system does in case of a broken CAN connection between the RS units, and enables the "Number of inverters in the system" setting below. Default is enabled.

If three RS units are configured in three phase, each individual unit will only continue to work if it sees at least one other unit. This feature is only relevant in combination with the "Continue with missing phase" feature.

- **Number of inverters in the system:** Enter the total number of RS units installed in the system. This should be set to 3 for a 3 phase RS system.

In case a CAN connection is broken between two units the network is split into segments, this setting is used to determine the largest and shut down the smaller segment to prevent them from continuing on their own unsynchronised.

Note that setting the option "Continue with missing phase" to disabled overrules this behaviour in such a way that it always ensures that all three phases must be powered at all times, so a broken CAN connection in a 3 phase setup will shut down all units.

- **Minimum number of inverters to start:** Choose the minimum number of inverters that must be present per phase when starting the system.

In case a CAN connection is broken between two units the network is split into segments, this setting is used to determine the largest and shut down the smaller segment to prevent them from continuing on their own unsynchronised.

Setting this to 3 means that all 3 units in a 3 phase Multi RS system must be present to start. If the "Continue with missing phase" option is also enabled, once the system is operational it will not shutdown if the number of inverters operational per phase drops below this figure (as long as the remaining inverters can power the load).

- **Continue with missing phase:** It is possible to configure the system so that if one unit is offline (for example due to it being physically switched off or a firmware update in case there is no grid connection to allow pass-thru), the other units can continue to operate and provide AC output power to their respective phases.

By default, the 'continue with missing phase' is disabled. Switching one unit off with the physical switch will make that unit switch off. If the unit is one of three units that are in three phase, then the others will also turn off as well.

If configured with 'Continue with missing phase' enabled, and minimum number of units is sufficient, then output to the other phases will continue even though its down to less phases than configured.

The 'Continue with missing phase' configuration option SHOULD NOT be enabled if there are specific three phase loads connected that require all three synchronised phases to operate (such as a three phase electric motor).

In that situation maintain the default 'disabled' setting for "Continue with missing phase".

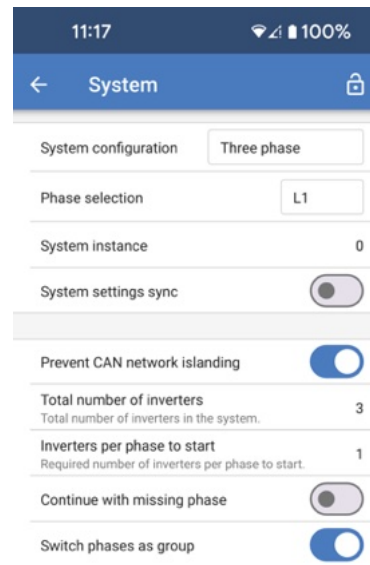



Attempting to run a three phase load with only two phases operating could result in damage to your appliance.



If you have configured the system to continue to operate with a missing phase, and there is an issue with the VE.Can communications between the units (such as the wire being damaged), then the units will continue to operate, but will not be synchronising their output wave forms.

- **Switch phases as group:** Disabling this option will allow the system to continue working even if one or two phases from the AC input are missing. The system will continue to produce three phase output from the AC-Out terminals.

This can also be used if a three phase output is required, but there is only one phase available from the grid or generator.

Note on redundancy and continuous output during firmware updates

A three phase system can be firmware updated without losing power on the AC output.

Make sure that there is stable AC input available when starting the update and the unit currently being updated will switch to AC-passthrough mode.

The AC synchronisation mechanism used for 3 phase has a 'protocol' version embedded.

Units can work together even with different firmware versions, as long as they are running the same protocol version.

This allows for continuous uninterrupted supply even when updating firmware, as the units will individually update one at a time, while others continue to synchronise and provide the stable AC output.

If Victron needs to change the 'protocol' version number, it will be clearly noted in the firmware change log. Always read this before updating.

In the event that there are multiple protocol versions running on the same VE.Can bus, all units will indicate error #71 until they are all updated to the same version.

Known Issues

- The 'UPS function' is too sensitive in 3 phase operation compared to stand-alone operation. Disable the 'UPS function' in case the Multi disconnects frequently from the AC input.
- Charge currents are not yet balanced across the 3-phases when the charger is in voltage-controlled mode.

5. VictronConnect setup, configuration and operation

5.1. Setup

The following steps are necessary to successfully connect the Multi RS Solar via Bluetooth and the VictronConnect app:

1. Make sure that Bluetooth is enabled on your Multi RS Solar. Bluetooth is enabled by default.



If Bluetooth has been disabled before then you'll need to connect to the Multi RS Solar using a VE.Direct to USB interface and the VictronConnect app to enable it again.

2. Download and install the VictronConnect app from the App Store or Google Play.
3. Open the VictronConnect app and scroll through the list of devices for the Multi RS Solar.
4. Tap on it to launch the pairing dialog. Enter the default pairing code which is either 000000 or is a unique PIN printed on the serial number sticker of the Multi RS Solar.
It is strongly advised, when prompted, to change the default PIN to a different one of your choice.
5. Once pairing is successful then the Overview page will be displayed.

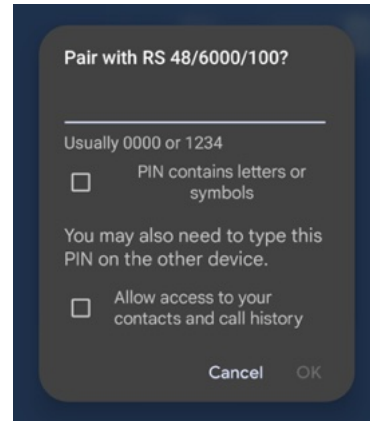

5.2. Overview page

The main overview page provides at-a-glance information of the Multi RS Solar. It is divided into four tabs:

- **Overview:** Instant readout of the basic state of the solar power yield, AC input and AC output.
- **Status:** Instant readout of the basic state of the MPPT charger.
- **History:** View up to the last 30 days of solar and battery data.
- **Trends:** Review current trend data.

Overview:

- **AC input:** The top left icon displays the AC input power. A negative value means that power is being exported to the grid.
- **Solar:** This shows the total amount of PV power being produced. In case of more than one MPPT tracker then the power produced by each tracker will also be displayed.
- **AC output:** The AC output power is displayed.
- **Battery:** Below the battery graphic, the voltage, current and state of charge are shown.



Status tab:

The status tab provides more detailed information than the overview tab.

- **AC Input:** AC input power, current, power and frequency as shown. Negative values indicate that power is being exported.
- **AC Output 1:** Shows the power, current, voltage and frequency at the AC output.
- **AC Output 2:** This shows the same parameters as the AC output 1.
- **Solar:** Displays the PV power, current and voltage of each tracker in this device.
Additionally, the total PV power of all MPPT trackers connected to the same VE.Can network are displayed.
- **Battery:** The battery voltage, state of charge, current and DC ripple voltage are highlighted.
- **Relay:** The status of the relay contacts is shown. If the relay mode is set to manual, then the relay can also be controlled here by tapping on the status dropdown at the right.



More detailed state information:

In case the Multi RS Solar has a problem, then a reason may be provided alongside an exclamation symbol. In this example "Why is AC in disconnected?"

Tap this information field to bring up a popup window which will provide more information and some troubleshooting tips.

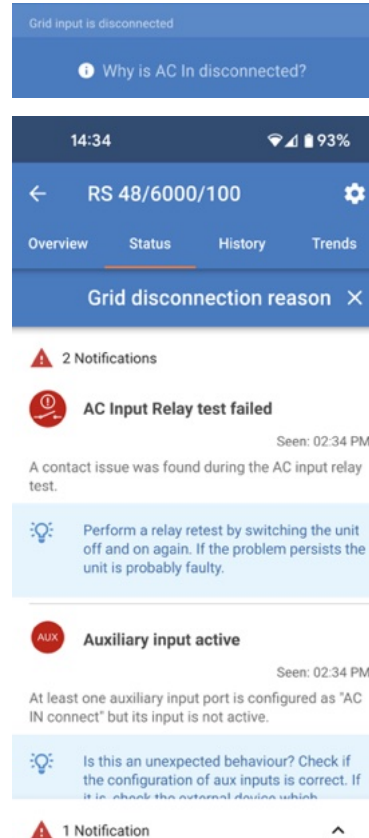

History tab:

- Up to 30 days of historic data is displayed.
- Bar graphs show the solar yield in kWh. The shaded areas highlight the time spend in the different charging stages.
- The "Solar panel" area records the total solar yield in kWh, maximum PV power and voltage.
- Maximum and minimum battery voltages are stored in the "Battery" section.
- If any errors were raised that day then they are shown with an orange circle.
- Total energy consumption for the day is totalled in kWh.
- Lifetime total energy produced by the connected Multi RS Solar. The totals can be reset and so "Since reset" keeps the record yield since then.
- To export the graph as a .csv you can tap the triangular three dot icon at the top of the graph area. You'll then be presented with various methods by which to share the .csv (e.g. email, WhatsApp etc.).

 Tap the fragmented square icon in the top left of the graph area to rotate the graph. This will allow you to see a wide view of the graph with more days displayed at once.



Trends tab:

- Two different data points can be selected using the drop down menus just above the graph.
- A graph will be rendered according to the selected parameters.



5.3. Settings page

The Settings menu is accessible by pressing the cog wheel from the top right of the Overview page.

The following menu options are available:

- **General:** Define the general settings for the Multi RS Solar.
- **Grid:** Grid disconnect and reconnect voltage limits can be set including the option to monitor the PE to neutral voltage.
- **Battery:** Adjust the charging parameters for the battery.
- **Solar:** Switch PV optimisation on or off and set custom names for each PV tracker.
- **Inverter:** Set the output voltage of the inverter and the behaviour of the ground relay.
- **On/Off:** There are more detailed options beyond the basic on/off capability of the physical switch.
- **Relay:** Select from a variety of relay modes for the internal relay.
- **Aux input:** Pick one function for each of the auxiliary inputs.
- **Display:** Choose how the LCD backlight behaves and the preferred temperature unit.
- **AC input control:** Provides various options to control when the AC input is connected or disconnected.
- **ESS:** Setup the energy storage system mode, and settings related to each mode.
- **System:** Designate how many units are in the system, and which phase they belong to.

Tap the three vertical dots in the top right corner of the settings page to perform the following actions:

- **Import settings from file:** Import previously saved settings from a file in the settings library.
- **Save settings to file:** Save the current settings to a file, which will be stored in the settings library. This file can be used as a backup to restore settings on this Multi RS Solar, or to easily apply the same settings to another one.
- **Share settings:** Share the settings file via email or other social apps.
- **Product info:** Displays the Multi RS Solar model number and serial number. There is also a switch to enable or disable Bluetooth.
- **Reset to defaults:** Reset all settings to the factory defaults. This will mean that any customised settings will be lost. Setup will need to be performed again, or imported from a previously saved settings file.

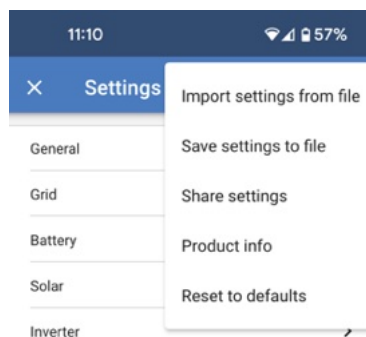
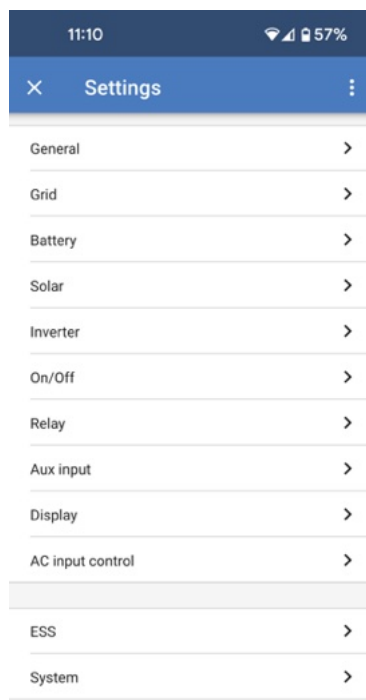

5.4. Product info

To get to the Product info page, tap the 3 vertical dots icon from the Settings page.

- **Product:** Shows the product name and the model number.
- **Serial number:** Shows the serial number of the Multi RS Solar.
- **NMEA 2000 device instance:** Displays the network device instance number for this particular device.
- **Pin code:** The Pin code is hidden but it can be changed using the change button to the right.
- **Custom name:** Change the friendly name of the Multi RS Solar.
- **Firmware:** Displays the current firmware version running on the Multi RS Solar.
- **Bootloader:** The bootloader version.
- **Bluetooth:** Enable or disable the Bluetooth functionality of the Multi RS Solar.



Note that if you disable Bluetooth, then connection to this device via Bluetooth will no longer be possible after you return to the Device list or exit the VictronConnect app. You'll need to connect using a VE.Direct to USB interface in order to enable Bluetooth again.

- **Instant readout via Bluetooth:** Enable this setting to display the most important data of the Multi RS Solar on the Device list page.
- **Instant readout details:** Tap "SHOW" to see the encryption data used for the Instant readout.

- **Lock product settings:** Use this option to lock the settings of the Multi RS Solar with a password. This will prevent others from changing critical settings without the password.

Tap "Add lock" to proceed to the "Lock product settings" page.

- **Product settings password:** Supply a password which will be used to unlock the product settings.

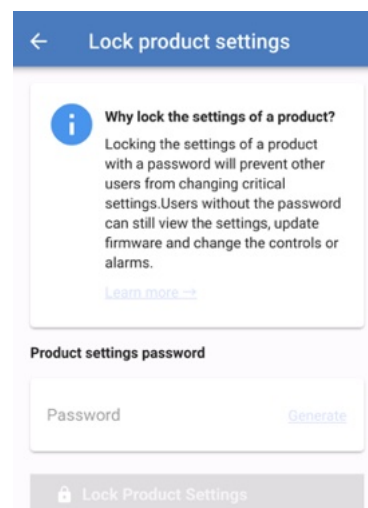
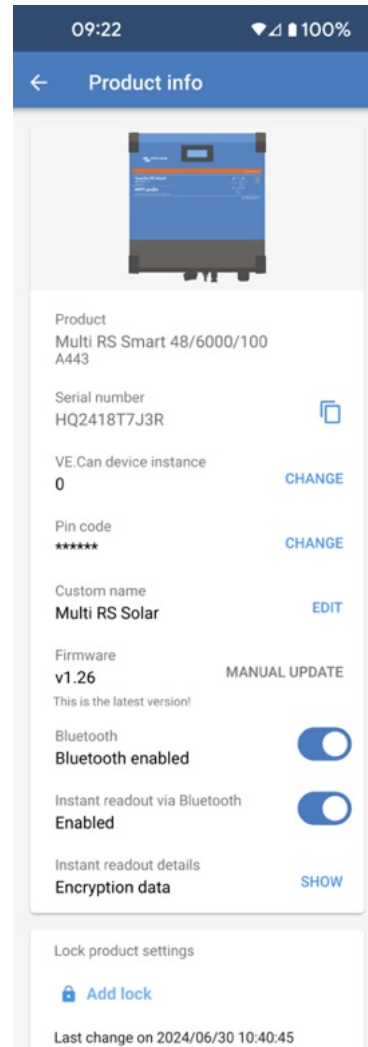

5.5. General

Use the General settings to configure the following:

- **Mode:** Tap the box on the right to change the operating mode of the Multi RS Solar.
- **Output frequency:** Set the nominal output frequency that the Multi RS Solar will produce. Choose between 50Hz or 60Hz.
- **AC input type:** Select the type of AC source that will be connected to the AC input of the Multi RS Solar. Choose between "Grid," "Generator," or "Shore power." If there is no AC input, then you can choose "Not available."

These settings are only used to change the input type on the VRM dashboard, they don't change the functionality of the Multi RS Solar. The icon and text will change accordingly. VRM will then be able to record the relevant energy source being used, and the corresponding graphs will show energy used from generator, or from grid, for example.

Choosing "Shore power" will display the input current limit on the VRM dashboard.

- **Moderate generator load changes:** When enabled, sudden changes in the load on the AC output will be initially supplied by the battery. The load on the generator will then be increased more gradually, allowing it time to regulate its engine power.



In conjunction with this setting, it is recommended to also disable the UPS setting on the grid settings page.

- **Energy meter support:** If you have an energy meter in the system, then you should enable this option.



"Energy meter support" is not provided by the older 'Single Tracker' model (PMR482602000).

- **AC current limit at energy meter:** This field will only be visible if "Energy meter support" is enabled. Adjust the current limit at the point that the energy meter is installed.
- **Current limit at AC input:** Adjust the current limit at the AC input of the Multi RS Solar.
- **Current limit overruled by remote:** Enable this option to allow the current limit to be adjusted remotely. For example, a GX device can be used to adjust the current limit remotely.

It is not possible to remotely set the current limit any higher than the level defined here.



Mode:

The physical on / off switch should be in the on position. The menu options below can override the on position of the physical switch.

The following options are available from the pop up menu:

- **On:** The Multi RS Solar will be on and fully functional. This is the default mode of operation.
- **Off:** The device will be switched off even if the physical switch is on.
- **Charger only:** This means that the inverter will be disabled and therefore the battery will not be discharged. Charging will be supplied by solar or AC input. If AC input is available, it will be transferred through to the AC output.
- **Inverter only:** In this mode, the AC input will be disconnected by the internal input relays. The inverter will provide AC to the output. Charging will not be possible from AC, but charging from solar will be possible.
- **Pass through:** AC at the input is transferred directly to the AC output. The inverter and the charger will be inactive. If AC input becomes unavailable then there will be no AC at the output either.

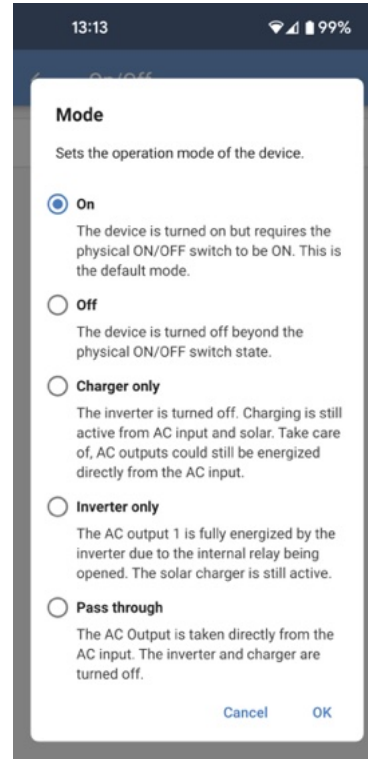

5.6. Grid

The grid settings page offers selection of a regional grid code and to adjust the AC input voltage limits.

- **Grid code:** The default option is None, grid feed in will not be possible.

Select the appropriate grid code for your region.

Please check the [ESS installation chapter \[21\]](#) for more information about grid code configuration settings.

- **Specs:** Tap "Show" to view the specifications of the currently selected grid code.

The below settings allow upper and lower AC input disconnection levels to be set. If the AC input voltage goes outside of these limits, then it will be disconnected and not passed through to the AC output. When the AC input is disconnected then, when the operation mode is set to "On," the inverter will provide power to the AC output.

- **AC low voltage disconnect:** The AC input will be disconnected when the voltage drops below this level.
- **AC low voltage connect:** After a low voltage disconnect, the AC input will re-connect when the voltage rises above this level.
- **AC high voltage connect:** After a high voltage disconnect, the AC input will re-connect when the voltage drops below this level.
- **AC high voltage disconnect:** The AC input will be disconnected when the voltage rises above this level.
- **UPS function:** Toggle this setting on to enable faster transfer from AC input to inverter power.
It may be necessary to disable this setting when using a generator. This is because the generator's output is less stable and may cause unwanted transfer to inverter when it is running.
- **NS protection log:** The network system protection log records the five most recent protection events. Tap "Show" to view any logged events.

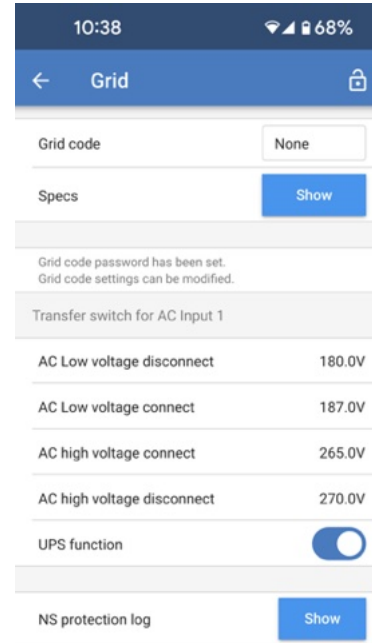

5.7. Battery

The Battery Settings page allows adjustment of all of the parameters related to the battery, which is connected to the Multi RS Solar. Some options will be greyed out if a fixed battery preset is selected. A "User defined" battery preset will allow all of the settings to be adjusted.

- **Battery voltage:** This option is always greyed out for the Multi RS Solar because it is only a 48V product.
- **Battery capacity:** Input the capacity of the battery in Ah. This is important for the internal battery monitor to calculate the battery state of charge correctly. It also defines the dynamic cut off discharge current levels.
- **Max charge current:** Adjust the maximum current that the Multi RS Solar will deliver to its battery terminals. By default, this is set to the maximum value. You may wish to reduce this if, for example, you have a smaller battery connected that cannot accept the maximum charge current.
- **Max discharge current:** Set the maximum current that the Multi RS Solar can draw at its battery terminals. Any additional power above this limit will be supplied from the AC input or PV which is connected directly to the unit. This setting is disabled by default.



This limit only applies if there is an active AC input present.

This setting is ignored in inverter mode, loads on AC output 1 can cause the limit to be exceeded!

- **Battery preset:** Use this to select the battery charge algorithm.
 - **Built-in preset:** Select one of the built-in presets (Normal, High and LiFePO4 2-wire BMS).
 - **User defined:** All parameters can be customized manually.
 - **Select preset:** Select a type from the VictronConnect app battery presets.
 - **Create preset:** Create a new custom battery preset in the VictronConnect app.
 - **Edit presets:** Edit an existing battery preset in the VictronConnect app.
- **Remote mode:** Configure what is connected to the REMOTE_L and REMOTE_H inputs on the user connector.
 - **Remote on/off:** A simple on/off switch to turn the Multi RS Solar on or off.
 - **2-wire BMS:** Use a wired BMS with allow-to-charge and allow-to-discharge signals like the SmallBMS. Note if 2-wire BMS is selected, then the unit will not start up until one is connected.
See [here \[15\]](#) for wiring the 2-wire BMS contacts to the User I/O connector.
- **Expert mode:** This on/off toggle enables editing expert settings in case your equipment has special requirements

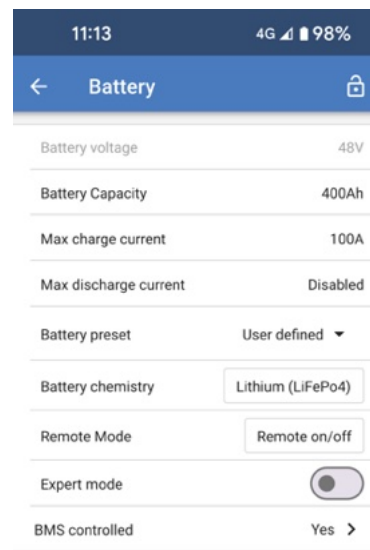

- **BMS controlled:** This item is only visible in case the unit is controlled remotely by a BMS. This is automatically enabled when the Multi RS Solar detects that it is connected to a system with a BMS. Click this field to change.

A confirmation box will pop up. Select "OK" to reset BMS control. The Multi RS Solar will no longer be controlled by a BMS. BMS control will be automatically enabled the next time it is connected to a system that has a BMS.

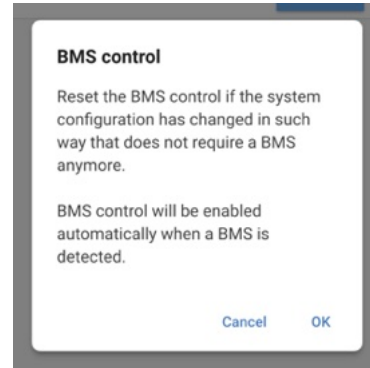

Low SOC shutdown:

- **Shutdown on low SOC:** Toggle this setting on if you wish the Multi RS Solar to stop discharging the battery based on the battery state of charge as determined by the battery monitor.
- **Shutdown SOC level:** Set the battery level that the Multi RS Solar will stop discharging the battery and the inverter will shut down.
- **Restart SOC level:** When the battery is recharging again, and the SOC level rises above this value, then the Multi RS Solar will restart.

Low SOC shutdown	
Shutdown on low SOC	<input checked="" type="checkbox"/>
Shutdown SOC level	10%
Restart SOC level	20%

Dynamic cut off:

- **Dynamic cut-off:** If this is disabled, then the low battery shutdown voltages will be at fixed levels defined below.
- **Low battery shutdown:** Specify a fixed voltage at which the Multi RS Solar will shutdown.
- **Low battery restart & alarm:** After a 30 second delay the Multi RS Solar will restart. After three restarts then the combined inverter/charger and MPPT solar charger will stop trying to restart and remain shutdown until it is reset or the Charge detect voltage level is exceeded.
This is also the voltage level at which a low battery alarm will be triggered.
- **Charge detect:** If the Multi RS Solar has shut down due to low battery then the voltage must rise above this level before it will restart.

Dynamic cut off	
Dynamic cut off	Disabled >
Low battery shut down	48.00V
Low battery restart & alarm	49.00V
Charge detect	50.00V

The Dynamic cut-off settings page will be displayed if it is enabled in the Dynamic cut off section as above. The discharge current levels are dependent upon the battery capacity. It is important that the battery capacity setting is correct for the discharge current levels to be relevant for the installation.

- **Enable dynamic cut-off:** If this is enabled, then the low battery shut down voltages will be dynamic and will depend upon the present battery discharge current.

There are four different fields where you can set the cut-off voltage at increasing discharge current levels.

Sustain voltage:

If the battery voltage gets very low due to a lack of charging, there is a good chance that they will be damaged. Even small loads can reduce the battery voltage so low that the battery would not be recoverable.

The sustain mechanism will help to prevent battery damage by preventing the battery voltage from getting any lower by applying a trickle charge to the battery.

- **During the first 24 hours:** Specify the voltage that the battery will be kept at for the first 24 hours, unless charging is resumed.
- **After the first 24 hours:** If, after 24 hours, the battery voltage has not increased above the setting defined for the first 24 hours, then the battery voltage will be increased to the level set here.

Click for more info. about sustain voltage: Tap this field to bring up a popup that will provide more information about how the sustain voltage works.

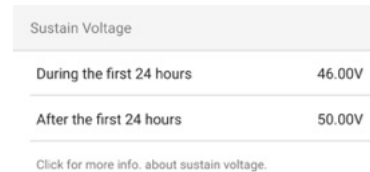
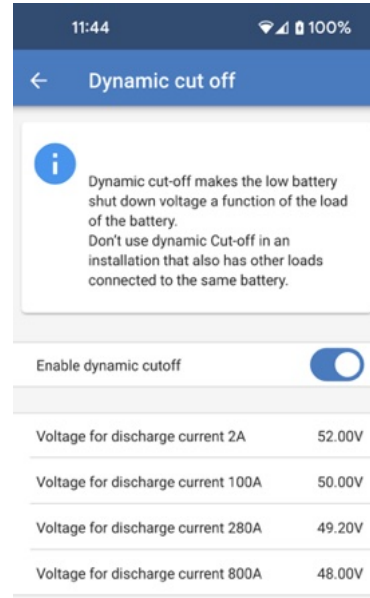

Charge voltages:

- **Absorbtion voltage:** Set the absorbtion voltage.
- **Float voltage:** Set the float voltage.
- **Equalization voltage:** Set the equalization voltage.
- **Storage voltage:** Set the storage voltage. It is possible that the Multi RS Solar will have a continuous AC supply, and some battery types can be damaged by an extended float voltage being applied to them. The storage voltage can be set lower than the float voltage for extended storage times when the battery is not being cycled.

Equalization:

- **Automatic equalization:** Set up the frequency of the auto equalize function. Available options are between 1 and 250 days.

Equalization is typically used to balance the cells in a lead battery and also to prevent stratification of the electrolyte in flooded batteries. Whether (automatic) equalization is necessary or not depends on the type of batteries and their usage. Consult your battery supplier for guidelines.

When the automatic equalization cycle has initiated, the charger applies an equalization voltage to the battery as long as the current level stays below the equalization current percentage setting of the bulk current.

In the case of all VRLA batteries and some flooded batteries, automatic equalization ends when the voltage limit (maxV) has been reached, or after a period equal to (absorption time/8), whichever comes first.

For all tubular plate batteries and also for the user-defined battery type, automatic equalization will end after a period equal to (absorption time/2).

For the lithium battery type, equalization is not available.

When an automatic equalization cycle is not completed in one day, it will not resume the next day. The next equalization session will take place according to the interval set in the 'Auto Equalization' option.

When an automatic equalization cycle is not completed in one day, it will not resume the next day. The next equalization session will take place according to the interval set in the 'Auto Equalization' option.

- **Manual equalization:** Tap "Start now" to begin equalization immediately. The duration is limited to 1 hour. This should only be initiated during absorbtion or float stages and when there is sufficient sunlight.

Voltage compensation:

- **Temperature compensation:** Many battery types require a lower charge voltage in warm operating conditions and a higher charge voltage in cold operating conditions.

The configured coefficient is in mV per degree Celsius for the whole battery bank, not per cell. The base temperature for the compensation is 25°C (77°F), as shown in the chart below.

With a temperature sensor installed on the User I/O connection block, the actual battery temperature will be used for compensation throughout the day.

Battery limits:

- **Low temperature cut-off** This setting can be used to disable charging at low temperatures as required by lithium batteries.

For Lithium Iron Phosphate batteries this setting is preset at 5 degrees Celsius. For the other battery types it is disabled. When creating a user-defined battery, the cut-off temperature level can be adjusted manually.

Charge voltages	
Absorption voltage	59.60V
Float voltage	55.20V
Equalization voltage	62.00V
Storage voltage	52.80V
Equalization	
Automatic equalization	Disabled
Manual equalization	Start now
Voltage compensation	
Temperature compensation	-64.80mV/°C
Battery limits	
Low temperature cut-off	Disabled

When "Expert mode" is enabled, the following additional settings will become available:

Bulk:

- **Re-bulk voltage offset:** Set the voltage offset that will be used over the float voltage setting that will determine the threshold that the charge cycle will restart.

For example, with a Re-bulk voltage offset of 0.4V and a float voltage setting of 54.0 V, the voltage threshold that will be used to restart the charge cycle will be 53.6 V. In other words, if the battery voltage drops below 53.6 V for one minute, the charge cycle will restart.

Absorption:

- **Absorption duration:** Select "Fixed" or "Adaptive". When you tap on the box to the right a detailed explanation for each option will pop up.
- **Maximum absorption time:** Set the absorption time limit. This is only available when using a custom charge profile.
- **Tail current:** Set the current threshold that will be used to finish the absorption phase before the maximum absorption time expires. When the battery current gets below the tail current for one minute, the absorption phase will end. This setting can be disabled by setting it to zero.
- **Repeated absorption:** Choose how often the automatic absorption stage should be repeated.
Setting the interval time to 0 will disable repeated absorption.
- **Repeated absorption duration:** Adjust the length of time that a repeated absorption stage will be.

Equalization:

- **Equalization current percentage:** Set the percentage of the Max charge current setting that will be used when equalization is performed.
- **Automatic equalization:** If enabled, then the Multi RS Solar will perform an equalization stage automatically at a chosen time interval.
- **Equalization stop mode:** Equalization can be set to either stop automatically when a chosen voltage level is reached or when a fixed amount of time has elapsed.
- **Maximum equalization duration:** The maximum duration that an equalization stage will last in any case.
- **Manual equalization:** Perform a manual equalization stage immediately. A manually triggered equalization stage will last for a maximum of one hour.

Bulk	
Re-bulk voltage offset	1.60V
Absorption	
Absorption duration	Adaptive
Maximum absorption time	6h 0m
Tail current	3.0A
Repeated absorption	Every 7 days
Repeated absorption duration	1h 0m

Equalization	
Equalization current percentage	6%
Automatic equalization	Disabled
Equalization stop mode	Automatic, on voltage
Maximum equalization duration	1h 0m
Manual equalization	Start now

Battery monitor:

- **Peukert exponent:** Adjust the Peukert exponent value to suit the battery type being used. Consult the battery specification sheet for the correct value. If the Peukert value cannot be found, then typical use values are 1.25 for lead acid batteries and 1.05 for lithium batteries. A value of 1.00 will disable the Peukert exponent calculation.
- **Charge efficiency factor:** Due to charging losses, a battery will need more Ah to fully charge it again than the amount that was discharged from it. The default setting is 95%. Increase this value for batteries with a higher charge efficiency. For example, lithium batteries could be as high as 99%.
- **Discharge floor:** This is the lowest level that the battery should be discharged down to. For example, lead acid batteries should not be discharged below 50%.
- **State of charge when bulk finished:** Define the SOC of the battery as soon as the bulk stage is complete and the absorption voltage is reached.
- **Synchronize SOC to 100%:** Force the battery monitor to state 100%. Only use this when you are sure that the battery SOC is actually 100% and you want the battery monitor to reflect this.

Battery monitor	
Peukert exponent	1.25
Charge efficiency factor	95%
Discharge floor	50%
State of charge when bulk finished	85%
Synchronize SOC to 100%	<input type="button" value="Synchronize"/>

5.8. Solar

This page allows setting the Partial shading detection algorithm and giving each tracker a custom name.

- **Solar charger enabled:** You can turn the solar chargers on or off. Both MPPT trackers are affected by this setting.



This setting does not affect the PV trackers visibility.

PV Optimization:

- **Partial shading detection:** The default setting is enabled. It is recommended to leave this setting enabled. Only in some specific solar installations may it need to be disabled.

PV trackers names:

- Each tracker can be given a custom name. The column on the left will always display the tracker number and the column on the right will show the custom name if given.

The custom name will also be shown on the LCD on the front of the Multi RS Solar.

Tap on the row to set a custom name.

PV trackers visibility:

- Any unused trackers can be hidden from showing on the VictronConnect overview page, the front panel LCD and from VRM. Trackers will be visible if the switch is toggled on.

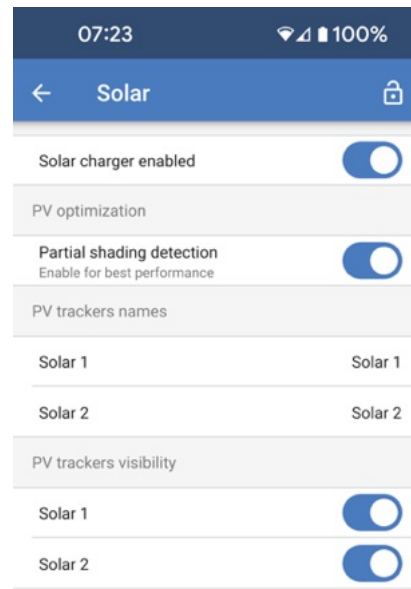

5.9. Inverter

Change settings related to the inverter here.

- **Output voltage:** Set the output voltage that the Multi RS Solar will produce when the inverter is running and the AC input is disconnected. If the AC input is connected, then the output voltage will be the same as the input voltage
- **Ground relay:** When enabled, the ground relay will close and create a Neutral-Earth bond when the AC input is disconnected and the inverter is running. If this setting is disabled, then the ground relay will never close.

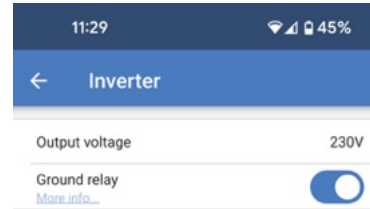

5.10. Relay

A programmable relay is available in the Multi RS Solar. The contacts are accessible via the User I/O terminals. See the User I/O functions table for the pinout.

- **Relay mode:** Tap in the box to select or change the mode of operation for the relay.

Some of the options allow additional settings for the relay contacts to remain closed for a minimum amount of time, or an amount of time after a condition has been cleared.

- **Minimum closed time:** Specifies the minimum amount of time that the relay will remain closed for after being set by a condition.
- **Relay off delay:** After an alarm condition has cleared, the relay will remain closed for this additional amount of time.

One of several relay modes can be selected from the list:

- **Alarm:** The relay is closed when either a high battery voltage or low battery voltage is alarm is active.
- **Low voltage relay:** Choose the parameters to set and to clear a low battery voltage alarm.
- **High voltage relay:** Choose the parameters to set and to clear a high battery voltage alarm.
- **Manual control:** Use this option to control the relay manually from the Settings - Relay page or from the Status page.
- **Always open:** The relay is not used and the contacts will always be open.
- **Inverting:** The relay contacts will close when the Multi RS Solar is inverting.
- **Low battery voltage:** The relay will close when the battery voltage falls below the set value.
 - **Low voltage relay:** When the battery voltage falls below the set level, the relay will close. The relay will open again when the voltage rises above a higher set voltage.
- **Fan:** The relay will close whenever the internal fan of the Multi RS Solar is running.
- **Charging:** The relay will be closed when the charger is charging and the battery voltage is between the low and high voltage limits.
 - **Low voltage relay:** The relay opens when the battery voltage falls below the lower set voltage and it closes again when the battery voltage is above the higher set voltage.
 - **High voltage relay:** The relay opens when the battery voltage is above the higher set voltage and it closes again when the battery voltage is below the lower set voltage.

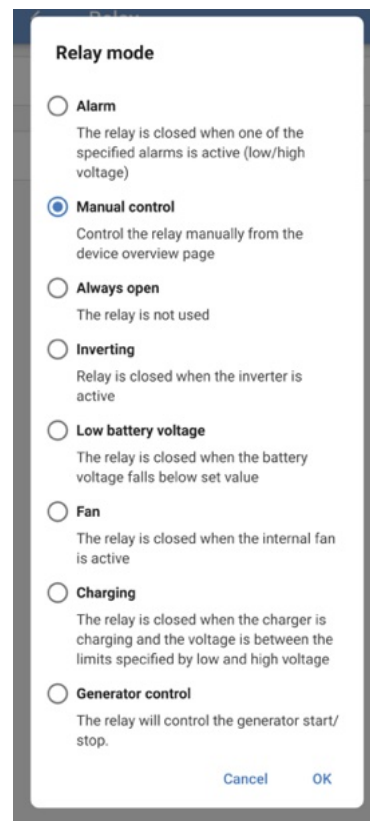
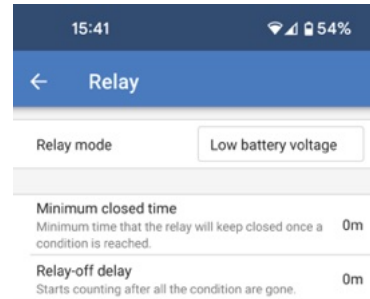

- **Generator control:** Choose this mode for the relay contact to control starting and stopping a generator.

There are a number of conditions which can be set to start and stop the generator.

Any or all of the conditions can be enabled using the toggle switch for each condition.

- **Relay polarity:** Select whether the relay contact closes to start the generator or if it opens to start the generator.
- **Start/Stop based on load:** Start the generator when the AC output load reaches a set limit.
 - **Start when load power is higher than:** Adjust the power limit that must be exceeded before the generator starts.
 - **Delay before start:** Set a delay from the high load condition activation before the generator actually starts. This is in case the high load condition is only a short term event.
 - **Stop when load is lower than:** Stop the generator when the load is below this power limit.
 - **Delay before stop:** Set a delay from the time the load condition is no longer active before the generator stops. This is in case the load goes above the activation limit again in a short amount of time.
- **Start based on battery voltage:** Start the generator when the battery voltage gets too low.
 - **Battery voltage:** Choose which battery voltage measurement to use for voltage based generator starting.
 - **When voltage is lower than:** The generator will start when the voltage falls below this value.
 - **Delay before start:** Allow a period of time after the condition is set before the generator starts.
- **Start based on state of charge:** The generator will start when the battery SOC goes below a set level.
 - **When SOC is lower than:** When the battery SOC falls below this value then the generator will start.

18:06 100%

Relay

Relay mode: Generator control

Relay polarity: Start by closing

Start/Stop based on load

Enable:

Start when load power is higher than: 4547W

Delay before start: 10s

Stop when load is lower than: 1364W

Delay before stop: 60s

Start based on battery voltage

Enable:

Battery voltage: Compensated

When voltage is lower than: 44.00V

Delay before start: 10s

Start based on the state of charge

Enable:

When SOC is lower than: 30.0%

Stop based on battery conditions

Based on: Battery voltage

Battery voltage: Compensated

When voltage is higher than: 57.60V

Delay before stop: 60s

Minimum run-time

Enable:

Minimum run-time: 3600s

- **Stop based on battery conditions:** Define conditions by which to stop the generator. Select one of the conditions by which to stop the generator.
- **Battery voltage:** When this option is chosen then you can set the voltage source to use, the voltage level above which the generator will stop, and also a stop delay.
- **State of charge:** Choose this option and define a state of charge level. When this SOC level is exceeded, then the generator will stop.
- **Bulk charge finished:** Specify an amount of time to wait after the bulk charge phase has finished before stopping the generator.
- **Absorbtion charge finished:** Define an amount of time that must pass before the generator stops, after the absorbtion charge phase has finished.
- **Minimum run time:** Set an overall minimum run time for the generator. This is to prevent short cycling the generator.

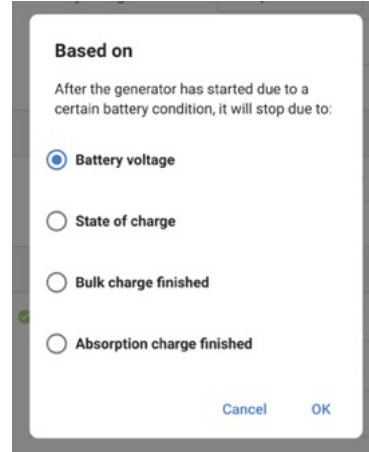

5.11. Aux Input

Each of the two Aux inputs can each be assigned a certain function.



If any grid code functions for Aux inputs have been defined in the [grid code settings \[21\]](#), these will take priority. Those functions will be shown but they will be greyed out.

See the [Auxiliary inputs \[18\]](#) section for more details.

There are two auxiliary inputs available via the user I/O terminal connector. These are labelled AUX_IN1 and AUX_IN2 and correspond to the ones defined in the Aux Input settings.

Different functions can be assigned to each input. If the same function is applied to both inputs, then they both need to be active before any action is taken.

By default, these are set to unused. Tap on the box to the right of one of the Aux inputs to select a function.



Choose one of the options from the popup box.



An Aux input is considered active when it's corresponding AuxIN+ terminal is connected to the common AuxIN- terminal.

- **Unused:** This input will have no function.
- **AC IN connects when active:** When the Aux input is active, then the AC input will connect if AC is available. If the Aux input is inactive, then the AC input safety relays will be open, and the Multi RS Solar will not connect to AC even if it is present.
- **AC IN connects when inactive:** When the Aux input is inactive, then the AC input will connect if AC is available. If the Aux input is active, then the AC input safety relays will be open, and the Multi RS Solar will not connect to AC even if it is present.
- **Safety switch:** The Multi RS Solar will only be on if the input is active.



The following two options are only available if a grid code has been set.

- **AC IN feed-in enabled when active:** Feed-in to the grid will be enabled if the input is active, regardless of any grid code settings. This may be requirement from the grid operator.
- **AC IN feed-in enabled when inactive:** Feed-in to the grid will be enabled if the input is inactive, regardless of any grid code settings. This may be requirement from the grid operator.



For the following option, if the Remote_H and Remote_L inputs are in a state that turns the Multi RS Solar off, then it will remain off and this input will have no effect.

- **Safety switch:** The Multi RS Solar will be on only if this input is active.

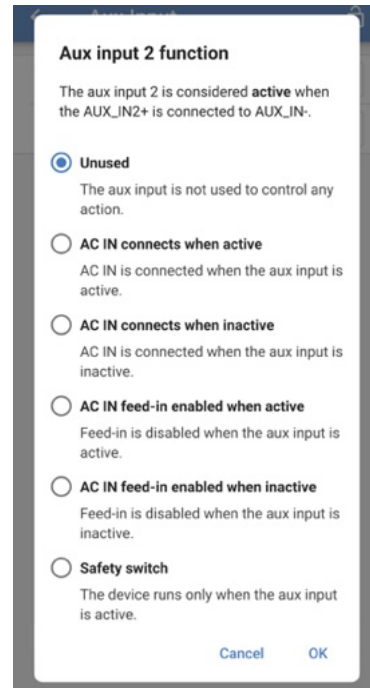

5.12. Display

These settings define the behaviour of the front panel LCD backlight and the temperature unit that it will display.

- **Display backlight:** Set up whether the front panel LCD backlight will be on or off.
 - **Always off:** The backlight will always be off.
The LCD may still be readable under strong ambient light but it will not emit light.
 - **Always on:** The LCD backlight is always on making it easy to read at a glance at any time.
 - **Automatic:** The LCD backlight is only on when the device is active.
- **Temperature unit:** Select which temperature unit will be used by the front panel LCD.
 - **Celcius:** Temperature is displayed in °C.
 - **Fahrenheit:** Temperature is displayed in °F.



This setting only affects the temperature unit on the front panel LCD.

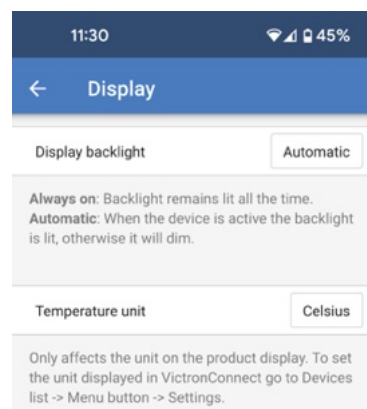

5.13. AC input control

The AC Input of the Multi RS Solar can be set up to connect to the incoming AC connection under a variety of conditions. This means that the AC loads, when higher than what the inverter can supply, shall continue to be powered from the AC input.



If you enable conditional AC input connection then the AC input will be disconnected. It will only connect if one of the conditions is satisfied.

- **Conditional AC input connection:** Toggle this option on to enable conditional AC input connection.

Load condition:

- **AC input connect based on load:** This option can be enabled to allow the AC input to be connected if the load on the AC output reaches a defined limit.
- **Connect when load is higher than:** After the AC load increases above this limit then the AC input will connect.
- **Delay before connection:** A delay can be set so that a certain amount of time can pass before the AC input connects due to a high load condition. Set this value to 0s if you don't want any delay.
- **Disconnect when load is lower than:** After a high AC load condition and the AC load reduces to a more normal level again, the AC input can then be disconnected, and all of the load will be supplied by the inverter.
A lower threshold can be set to ensure that any higher than normal load fluctuations have passed before disconnecting the AC input.
- **Delay before disconnection:** A delay for the disconnect limit can also be given.

Battery conditions:

- **Connect when SOC drops below:** Change this field to enabled. In the popup box set the minimum SOC that the battery will reach before the AC input is connected.

- **Connect when battery voltage drops below:** Tap this field and adjust the minimum voltage that the battery should reach before the AC input is connected.
- **Delay before connection:** A delay can be defined before the AC input is connected when either of the battery conditions are met.

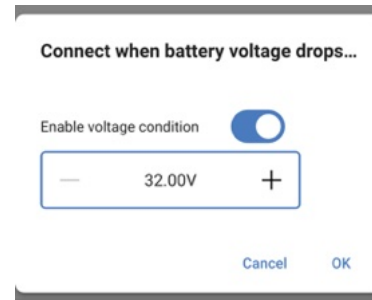

- **Disconnect AC input on:** Tap this field and then choose a battery condition by which the AC input will be disconnected.
- **Disconnect when voltage is higher than:** If "Battery voltage" is chosen in the previous field then you can define a battery voltage above which the AC input will be disconnected.
- **Delay before disconnection:** When the AC disconnect condition has been met, a delay can be set before the AC input is actually disconnected.

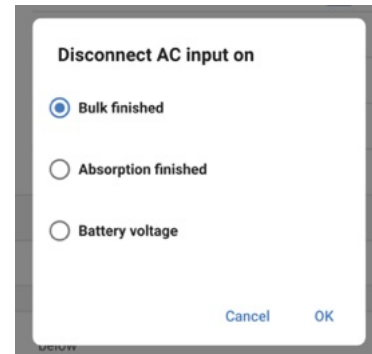

5.14. ESS

In some cases the user may want to only use the AC input to charge the battery when necessary, and instead allow the batteries to discharge to provide for the loads and recharge from solar.

To enable this flexibility there are several possible configuration options.

The ESS settings are available out-of-the-box without the need to install an assistant.

ESS relies on an AC input being present, so it does not provide useful functionality in an off grid system.



The ESS settings for the Multi RS Solar can only be changed using VictronConnect as shown below. There is currently limited functionality from the ESS menu of a GX device. There are currently no ESS controls from VRM.

The factory default operation when an AC input is connected to a Multi RS Solar is that the charger will begin charging the batteries up to the maximum AC input current and charge current limits. We call this factory default mode "Keep batteries charged."

- **ESS mode:** The factory default is "Keep batteries charged." Tap in the box to choose a different ESS mode. See the table below for details.
- **Minimum discharge SOC:** This is the lowest SOC that the battery will be allowed to discharge down to. Once this limit is reached then power for the loads will be supplied from the AC input.
- **Self-consumption from battery:** Allows energy from the battery to power all system loads or just the critical loads. This works in conjunction with one of the optimized ESS modes.



This option will only be visible if "Energy meter support" is enabled.

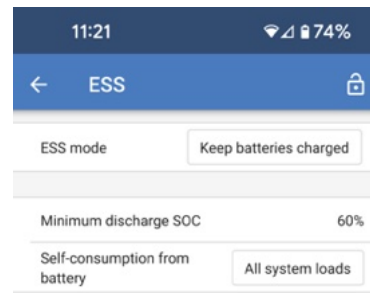

From the ESS mode pop box there are five options to choose from.

- **Optimized with batterylife:** When there is enough solar power to satisfy the loads, then the excess solar power will be used to charge the battery. The power stored in the battery will then be used when the solar power is not enough or during the night.

The batterylife algorithm will be active. This means that the minimum SOC level will gradually increase for each day that the battery is not fully charged. Once the battery gets fully charged then, the SOC level will reduce down to its originally set level.

This is suitable for lead acid battery chemistries.

- **Optimized without batterylife:** As above, when there is enough solar power to satisfy the loads, then the excess solar power will be used to charge the battery. The power stored in the battery will then be used when the solar power is not enough or during the night.

Batterylife is not used, and so the minimum SOC level will remain at its preset level.

This "Optimised" mode is best for lithium batteries.

- **Keep batteries charged:** In this mode, the batteries will be kept fully charged as long as the AC input is available. Loads will be supplied from the AC input. If there is enough solar power, then this will be used to supply the loads, and excess solar will charge the battery if it is not fully charged.

Use this mode in off grid installations to prevent feedback to a generator, which may be connected to the AC input.

This mode should also be used where grid is available, but feed in is not permitted.

- **External control:** There may be use cases where an external ESS control is required. There will be no automatic control of the ESS setpoints. All ESS setpoints will need to be written from an external appliance.
- **PV Inverter only (without batteries):** In this mode it is possible to use the Multi RS Solar without a battery. The unit operates as a normal PV inverter.



This option will only appear if a grid code has been set.

Do not connect any loads to the AC output.

Energy from the battery can be reserved to power only the critical loads on the AC output terminals.

- **All system loads:** ESS will allow energy from the battery to supply power to loads on the AC Output as well as loads connected between the energy meter and the AC input terminals.
- **Only critical loads:** Only critical loads connected at the AC output terminals will be powered from the battery. Non-critical loads connected between the energy meter and the AC input terminals will only be powered from grid energy and not the battery.

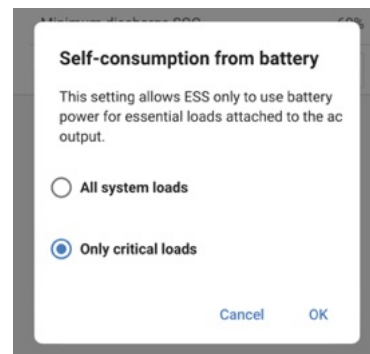
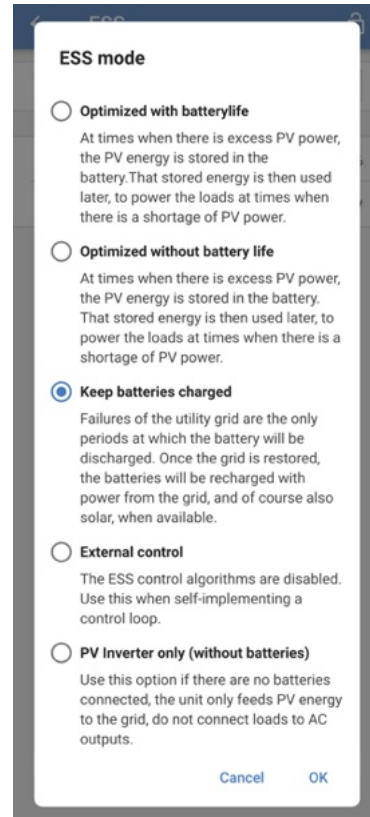

5.15. System

The System page allows setting up a Multi RS Solar to be a standalone unit or part of a three phase system. By default, it is set up to work as a single unit in standalone mode.



The Multi RS Solar can only be configured as standalone or three phase. A parallel configuration is not currently possible.

There will be different settings available depending upon which type of System configuration is selected.

The settings described here relate to a standalone system configuration.

- **System configuration:** Select either standalone or a three phase configuration.
- **Phase selection:** Choose which phase this current unit will be connected to. Each unit must be set to a different phase since only one unit can be allocated per phase.
- **System instance:** Devices with the same instance number will work together as a group on the AC side.
If you change the System instance then you can have multiple groups of units on the same physical VE.Can bus operating independently. Different groups will not synchronise with each other.
- **Prevent CAN network islanding:** Enables the CAN network islanding detection. The default setting is enabled.

If the physical CAN network is broken, this prevents separate CAN segments from running independently and getting out of sync with one another.

- **Total number of inverters:** This option will not be available if the above option "Prevent CAN network islanding" is not enabled.

Specify the total number of inverters that make up the system. In a standalone system, this will be 1.

If the CAN network is split into segments, this setting is used to determine the largest and shut down the smaller segment to prevent them from continuing on their own unsynchronised.

This results in a more reliable system than if the smaller segment tried to continue on its own unsynchronised (which will lead to overload or other less graceful shutdown issues caused by an unsynchronised AC output sine wave).

- **Inverters per phase to start:** This is the minimum number of inverters which must be present per phase when starting the system. Given that there can only be one Multi RS Solar per phase, this should be set to 1.

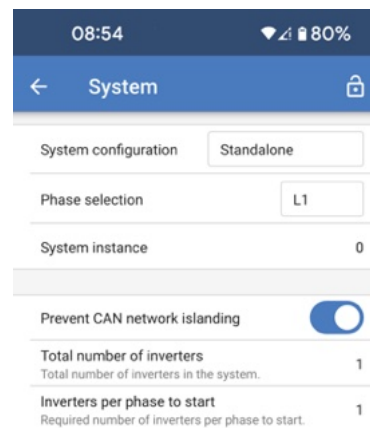

The settings described here relate to a three phase system configuration.

- **System configuration:** Select either standalone or a three phase configuration.

- **Phase selection:** Choose which phase this current unit will be connected to. Each unit must be set to a different phase since only one unit can be allocated per phase.

- **System instance:** Devices with the same instance number will work together as a group on the AC side.

If you change the System instance then you can have multiple groups of units on the same physical VE.Can bus operating independently. Different groups will not synchronise with each other.

- **System settings sync:** This option allows the synchronization of certain settings across multiple devices in a group. This helps to ease system configuration and to ensure consistent settings between members of the group.

See more details in the next section.

- **Prevent CAN network islanding:** Enables the CAN network islanding detection. The default setting is enabled.

If the physical CAN network is broken, this prevents separate CAN segments from running independently and getting out of sync with one another.

- **Total number of inverters:** Specify the total number of inverters that make up the system. In a three phase system with one inverter per phase, this will be 3.



This option will not be available if the above option "Prevent CAN network islanding" is not enabled.

If the CAN network is split into segments, this setting is used to determine the largest and shut down the smaller segment to prevent them from continuing on their own unsynchronised.

This results in a more reliable system than if the smaller segment tried to continue on its own unsynchronised (which will lead to overload or other less graceful shutdown issues caused by an unsynchronised AC output sine wave).

- **Inverters per phase to start:** This is the minimum number of inverters which must be present per phase when starting the system. Given that there can only be one Multi RS Solar per phase, this should be set to 1.

- **Continue with missing phase:** This is disabled by default. If enabled, then it would be possible for two other units to continue providing power to their respective phase.



Do not enable this option if you have three phase loads such as induction motors, which may be damaged if run with a missing phase.



If you have configured the system to continue to operate with a missing phase, and there is an issue with the VE.Can communications between the units (such as the wire being damaged), then the units will continue to operate, but will not be synchronising their output wave forms.

- **Switch as a group:** Disabling this option will allow the system to continue working even if one or two phases from the AC input are missing. The system will continue to produce three phase output from the AC-Out terminals.

This can also be used if a three phase output is required, but there is only one phase available from the grid or generator.

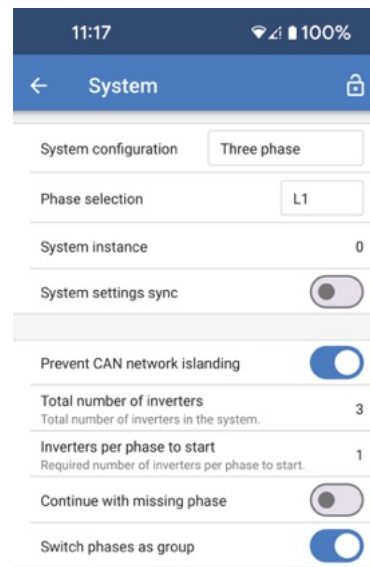

System settings sync:

When system settings sync is enabled, or when the system configuration is changed from "Standalone" to "Three phase", then a popup will appear asking which direction you want the settings to be synchronized for this device.



When settings sync is enabled, a change on any device in the group will be automatically propagated to the other units in the group.

- You can choose to disable sync if you don't want to use it.
- If this is the first device to be configured in this system, then you would likely choose to use the settings on this device for the rest of the system.
- If this device is a new member of the group, or is a new unit replacing a faulty one, then you can take the settings for this unit from the group.

Once settings sync is enabled on the unit, a banner will be displayed at the top of the main settings page.

This serves as a reminder that automatic settings synchronization is active and any changes made which are marked with this icon will be propagated to other units.

These are examples of synchronized settings, identified by their associated icons to the left.

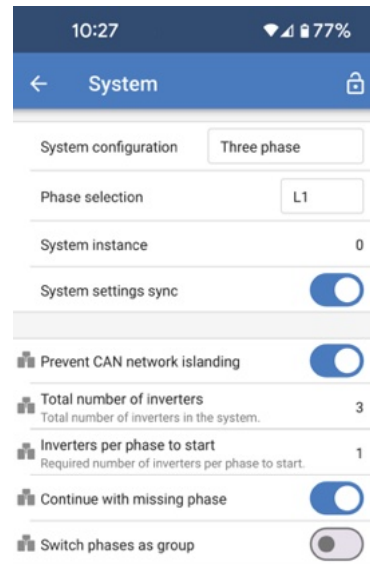
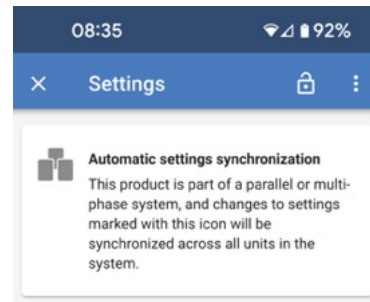
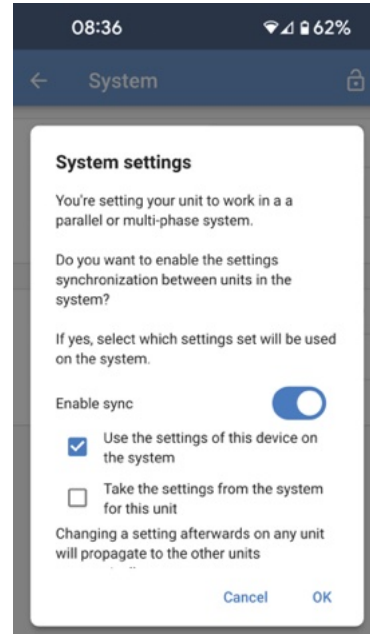

6. Operation

6.1. Device display

The Multi RS Solar has an LCD screen that displays operational information.

The pages will change one after the other, pausing for about six seconds on each one.

Inverter state: This shows when the Multi RS Solar is inverting.
Power output, Frequency, and AC voltage.

```
Inverter:      ***#
              41VA 50.0Hz 230V
              - Inverting -
```

AC input state: This shows the state of the AC input.
Power output, Frequency, and AC voltage are shown.
The bottom line shows the status of the AC input relay.

```
AC input:     ***#
              -5000W 50.0Hz 230V
              ACIN1 relay closed
```

Battery:

Battery Power (charging shows positive number, discharging shows negative number), Current, DC voltage, Temperature (*), State-of-charge (*) and Time-to-go (*). Battery state (e.g. discharging, bulk, absorption, float, etc).

Battery state: The second line of the display shows the status of the battery, as measured at the battery terminals of the Multi RS Solar itself. These values don't account for other charge sources or loads in the wider system.

Battery power, battery voltage and current.

The third line of the display shows the battery temperature and state of charge. These values may come from the system battery monitor if available.

```
Battery:     ***#
              1748W 54.12V 32A
              26°C 98%
              - Bulk -
```

Negative values indicate battery discharge.

The bottom line shows a battery status of "Discharging".

```
Battery:     ***#
              -22W 54.97V -0.4A
              26°C
              - Discharging -
```

Solar:

The solar power, voltage and current are shown on the second line.
There is a separate page for each MPPT tracker.







The daily yield and the total yield are also displayed.

```
Solar:       ***#
              1812W 178.9V 10.1A
              Today 0.29 kWh
              Total 0.3 kWh
```

If you have an AC PV inverter connected, then its power and yield will be displayed.

```
AC Solar:    ***#
              2500W 50.0Hz
              Today 9.89 kWh
              Total 551.3 kWh
```

In the top right of the display are other system information icons.

	Communicating on any interface (e.g., Bluetooth, VE.Can, etc.)
	Bluetooth Enabled, Icon colour changes when connected
	MPPT Active
	(Blinking) Error or Warning
	Inverter Active
	Battery, fill corresponds with voltage, blinks when empty

6.2. Protections and automatic restarts

6.2.1. Overload

Some loads like motors or pumps draw large inrush currents during start-up. In such circumstances, it is possible that the start-up current exceeds the over current limit of the inverter. In this case the output voltage will quickly decrease to limit the output current of the inverter. If the over current limit is continuously exceeded, the inverter will shut down for 30 seconds and then automatically restart. After three restarts followed by overload within 30 seconds of restarting, the inverter will shut down and remain off. To restart normal operation, disconnect the load, Switch Off the inverter, then switch it On.

6.2.2. Low battery voltage thresholds (adjustable in VictronConnect)

The inverter will shut down when the DC input voltage drops below the low battery shutdown level. After a minimum shutdown time of 30 seconds, the inverter will restart if the voltage has risen above the low battery restart level.

After three shut down and restarts, followed by a low battery shutdown within 30 seconds of restarting, the inverter will shut down and stop retrying based on the low battery restart level. To override this and restart the inverter, switch it Off, and then On, and limit loads to enable recharging of the battery with solar energy.

See the Technical Data table for default low battery shut down, restart and charge detect levels. They can be adjusted with VictronConnect (computer or app).

Additionally another external MPPT or battery charger can also be used to recharge the battery to reach the Restart Voltage or Charge Detect voltage level. !!! If using the allow to charge signal functionality, it must remain above the minimum voltage, so if the battery is completely dead it will not allow charging to start. In this case, you can temporarily disable this function in VictronConnect to allow charging to resume, then enable it again.

See the Technical Data table for default low battery shut down and restart levels. They can be changed with VictronConnect (computer or app). Alternatively Dynamic Cut-off can be implemented, see <https://www.victronenergy.com/live/ve.direct:phoenix-inverters-dynamic-cutoff>

6.2.3. High battery voltage

Reduce DC input voltage and/or check for a faulty battery- or solar-charger in the system. After shutting down due to a high battery voltage, the unit will first wait 30 seconds and then retry operation as soon as the battery voltage has dropped to acceptable level.

6.2.4. High temperature

A high ambient temperature or enduring high load may result in shut down to over temperature. The inverter will restart after 30 seconds. The inverter will continue to try and resume operation, and will not stay off after multiple retries. Reduce load and/or move inverter to better ventilated area.

7. Troubleshooting guide

For unexpected behaviour or suspected product faults, refer to this chapter.

Start by checking the common issues described here. If the problem persists, contact the point of purchase (Victron dealer or distributor) for technical support.

If you're unsure who to contact or if the point of purchase is unknown, refer to the [Victron Energy Support webpage](#).

7.1. Solar charger is inactive

7.1.1. PV voltage too low

PV voltage check procedure.



A very high voltage is present on the PV cabling even when the PV array is disconnected or switched off. Do not perform any of the procedures below unless you are a trained solar electrician. PV voltage can be up to 450V DC.

- Switch off the Multi and ensure there is no voltage present at the PV terminals coming from the device.
- Disconnect the MC4 connectors with a suitable tool.
- Measure the voltage on the PV cables. It is not advisable to use standard multimeter probes for this operation. Use a fully insulated MC4 test lead set connected to the multimeter.
- Confirm that the PV voltage measured is above the minimum PV start up voltage of 120V.
- The minimum PV start up voltage is 120V but needs to be above 65V for the MPPT to continue operating.

If there is insufficient voltage on the MC4 PV cables.

- Check the PV cables.
- Check the fuses and circuit breakers.
- Check for heavy cloud cover, bad weather and make sure it is not night time.
- Is there excessive shading or the PV modules are very dirty.
- Mechanical or electrical issues with one or more PV modules in the array.
- Faulty wiring between the PV array Multi
- Open or faulty circuit breakers
- Blown fuse
- Problems with a PV combiner.

If the MPPT still does not start after conducting the above checks then there may be a fault within the Multi

7.1.2. Reverse PV polarity

As long as the unit is installed within the published specifications, the PV input is protected internally against PV reverse polarity.

In the case of reverse PV voltage, the solar charger will not indicate an error.

The only way to detect reverse PV voltage is by the following signs:

- The controller is not charging the batteries, the charge current is zero.
- The controller is getting hot.
- The PV voltage is zero, or close to zero.

If this is the case check for reverse polarity using a multimeter by ensuring that the positive PV cable is connected to the positive PV terminal, and the negative cable is connected to the negative terminal.



Measuring PV voltage at the PV terminals of a solar charger should only be performed by an electrical technician.

7.1.3. Safety relays are closed.

Safety relays, which are visible in the service compartment at the PV inputs, may have closed. This only happens if the Multi RS Solar has protected itself from a hazardous situation.

Under normal operating conditions the small black flag on top of the relay should be in the "OK" position. If the flag indicates towards the position with a danger symbol then it is closed. When the relays are closed the PV array is short circuited to stop PV power from entering the Multi RS Solar. The PV fuses or circuit breakers in the installation may open.

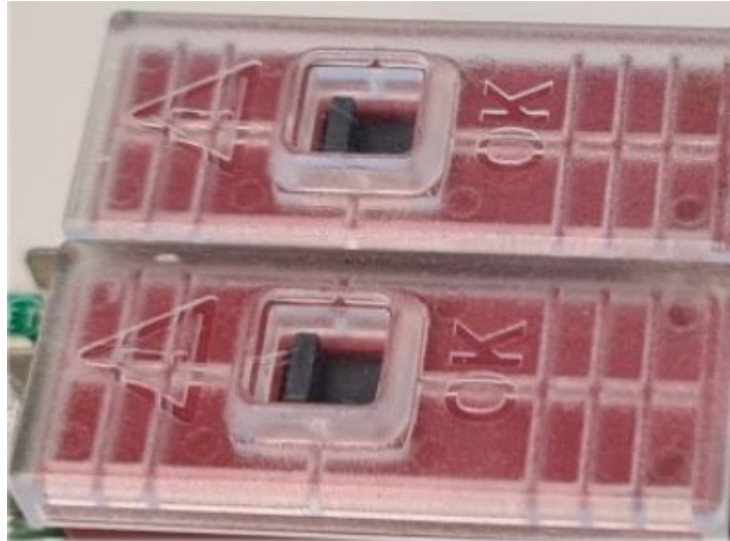

The fault cannot be cleared nor reset. The relays have closed to prevent further damage due to the internal fault.

The Multi RS Solar should be returned to the supplier.



DO NOT ATTEMPT TO RESET THE SAFETY RELAYS. THE RELAYS HAVE CLOSED TO PROTECT FROM A HAZARDOUS SITUATION.

7.2. Batteries are not being charged

There are a few situations that could cause the batteries to not charge.

This could be indicated by low or no battery current shown in the VictronConnect app.

- The battery is full, and no more current is needed.
- Wrong configuration (voltage or current set too low).
- The charger is externally controlled (ESS or DVCC).
- The battery temperature is too high and temperature-compensated charging is active or set incorrectly,
- Reverse PV polarity.

7.2.1. Battery is full

Once the battery is full the solar charger will stop charging or will greatly reduce the charge current.

This is especially the case when at the same time the DC loads in the system are not consuming any power from the battery.

To find out what the state of charge (SoC) of the battery is, check the battery monitor (if present), or alternatively, check what charge stage the controller is in. Also, observe that the solar cycle is (briefly) progressing through these charge stages at the beginning of the daily charge cycle:

- Bulk stage: 0-80% SoC.
- Absorption stage 80-100% SoC.
- Float or storage stage: 100% SoC.

Be aware that it can also be possible that the solar charger thinks the battery is full, while in reality, the battery is not full. This can occur when the charge voltages have been set too low, causing the solar charger to prematurely switch to the absorption or float stage. For more information see the [Battery settings too low](#) chapter.

7.2.2. Battery settings too low

- In the VictronConnect app, navigate to the solar charger "Settings" menu and select the "Battery" menu.
- Check if the "Max. charge current" value is set correctly and corresponds with the battery manufacturer's recommendation.
- Check that the battery charge voltages are set according to the battery manufacturer's specifications.

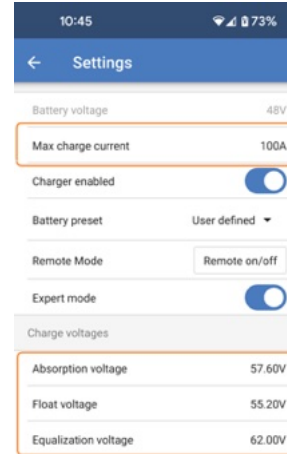

7.2.3. Reverse PV polarity

As long as the unit is installed within the published specifications, the PV input is protected internally against PV reverse polarity.

In the case of reverse PV voltage, the solar charger will not indicate an error.

The only way to detect reverse PV voltage is by the following signs:

- The controller is not charging the batteries, the charge current is zero.
- The controller is getting hot.
- The PV voltage is zero, or close to zero.

If this is the case check for reverse polarity using a multimeter by ensuring that the positive PV cable is connected to the positive PV terminal, and the negative cable is connected to the negative terminal.



Measuring PV voltage at the PV terminals of a solar charger should only be performed by an electrical technician.

7.3. Batteries are undercharged

This chapter deals with possible reasons why the solar charger is not sufficiently charging the batteries and the steps you can take to check or remedy the situation.

Some signs of undercharged batteries:

- The batteries take too long to charge.
- The batteries are not fully charged at the end of the day.
- The charge current from the solar charger is less than expected.

7.3.1. Insufficient solar

Check if the solar charger reaches the float charge stage each day.

To investigate look at the history tab in the VictronConnect app. The histogram displays how long the batteries have been charged in the Bulk, Absorption and Float stage each day, for the last 30 days. If you click on one of the histogram columns you will see a breakdown of the charge stages.

You can use the charge times to see if the PV array is properly sized for your requirements.

A system that never reaches the float stage could have the following issues:

- Not enough solar panels.
- Too much load.
- A problem with the array causing it to have a reduced power output.
- For more potential reasons see paragraph: "PV power or yield less than expected".



System spending all its time in bulk with breakdown of charge stages - System in bulk and absorption

7.3.2. Too much DC load

The solar charger does not only charge the batteries, it also provides power for the system's loads.

The battery will only be charged when the power available from the PV panels exceeds the power being drawn by the loads in the system, like lights, fridge, inverter, and so on.

If the system battery monitor is correctly installed and configured you can see how much current is going in (or out) of the battery and the solar charger will tell you how much current the solar array is generating.

A positive sign alongside the current reading means that current is flowing in to the battery, while a negative sign means that current is being drawn from the battery.

7.3.3. Battery cable voltage drop

If there is a voltage drop over the battery cables, the solar charger will output the correct voltage, but the batteries will receive a lower voltage which can potentially lead to undercharged batteries. A voltage drop in excess of 2.5% is unacceptable.

The voltage drop will cause the following:

- Battery charging will take longer.
- The battery receives a too-low charge voltage.
- There is a loss of charge power.
- The battery cables heat up.

The voltage drop is caused by the following:

- Battery cables with insufficient cross-sectional area.
- Badly crimped cable lugs or terminals.
- Loose terminal connections.
- Bad or loose fuse(s).

For more information on cabling issues and voltage drop see the [Wiring unlimited book](#).

Battery cable voltage drop check

This check must be performed while the charger is charging with a full current. Typically best done in the morning. Use the VictronConnect app to check the output current.

1. Measure the voltage on the battery terminals of the solar charger using the VictronConnect app or a multimeter.
2. Measure the battery voltage on the terminals of the battery using a multimeter.

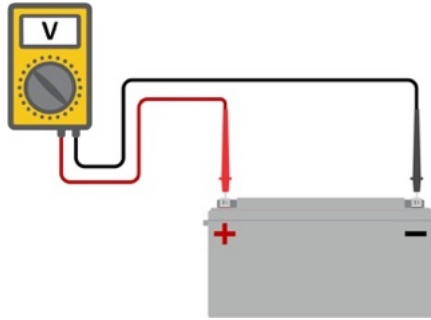

3. Compare the two voltages to see if there is a voltage difference.

7.3.4. Wrong temperature compensation setting

If the temperature compensation coefficient is set incorrectly, the batteries can be undercharged or be overcharged. The temperature compensation can be set via VictronConnect or via a display.

To find out the correct temperature compensation coefficient setting for your battery, refer to the battery documentation. When in doubt use the default value of $-64.80\text{mV}/^\circ\text{C}$ for lead acid batteries and disable the temperature compensation setting for lithium batteries.

7.4. Batteries are overcharged



Batteries that are being overcharged are very dangerous! There is a risk of battery explosion, fire or acid leakage. Do not smoke, create sparks or have open flames in the same room as where the batteries are located.



Overcharging batteries will cause battery damage and can be caused by:

- Incorrect charge voltage settings.
- Applying equalization while the battery is not suitable for equalization.
- High current and undersized batteries.
- Battery faults.
- Too high current, while the battery is not accepting charge anymore because of aging or prior mistreatment.

7.4.1. Battery charge voltages too high

If the battery charge voltages are set too high this will cause the batteries to overcharge.

Check if all the battery charge voltages (absorption and float) are set correctly.

The charge voltages have to match the recommended voltages as stated in the battery manufacturers documentation.

7.4.2. Battery unable to deal with equalization

During equalization, the battery charge voltage will be quite high and if the battery is unsuitable to be equalized, the battery will be overcharged.

Not all batteries can be charged with equalization voltages. Check with the battery manufacturer if the battery you are using needs a periodic equalizing charge.

Generally speaking, sealed batteries as well as lithium batteries don't need and therefore should not be equalized.

7.4.3. Battery old or faulty

A battery that is at the end of its service life or has been damaged by incorrect use, can be prone to being overcharged.

A battery contains a number of cells that are connected in series. When a battery is old or has been damaged, a likely scenario is that one of these cells is not operational anymore.

When the faulty battery is charged, the damaged cell will not accept charge and the remaining cells will receive the broken cell's charge voltage and thus will be overcharged.

To fix this, replace the battery. In case of multiple battery system replace the whole battery bank. It is not recommended to mix batteries of different ages in one battery bank.

It is hard to tell what has exactly happened to a battery during its lifetime. The solar charger will keep 30 day of battery voltage history. If the system also contains a battery monitor, or if the system is connected to VRM, the battery voltages and the cycle history of the battery can be accessed. This will give a complete picture of the battery history and it can be determined if the battery is near the end of its service life or has been abused.

To check if the battery is close to its cycle life:

1. Find out how many charge and discharge cycles the battery has been subjected to. Battery lifetime correlates to the number of cycles.
2. Check how deep the battery has been discharge on average. A battery will last for less cycles if deeply discharged, compared to more cycles if discharged less deep.
3. Refer to the battery data sheet to find out how many cycles at what average discharge the battery is capable of. Compare this with the battery history and determine if the battery is near the end of its service life.

To check if the battery has been misused:

1. Check if the battery has been totally discharged at all. Total and very deep discharge will damage a battery. Check the battery monitor setting history on the VRM portal. Look for the deepest discharge, the lowest battery voltage and the number of full discharges.
2. Check if the battery has been charged with a too high voltage. Very high charge voltage will damage the battery. Check the maximum battery voltage and the high voltage alarms in the battery monitor. Check if the measured maximum voltage has exceeded the battery manufacturer recommendations.

7.5. PV problems

This chapter deals with the remaining solar problems that were not already discussed in the earlier chapters.

7.5.1. PV yield less than expected

Check the solar panel yield history in the VictronConnect app. Check the total maximum power (Pmax) for each day. Does this match the array power?

To find the potential solar yield per day for a specific PV array size in a specific geographical location, use the MPPT sizing calculator on the [solar charge controller product page](#).

These are some of the reasons why the array is generating less power than expected:

- Low sun angle, seasonal differences or morning/evening.
- Cloud cover or bad weather.
- Shading from trees or buildings.
- Dirty panels.
- Incorrect orientation and/or inclination.
- Broken or faulty solar panel(s).
- Issues with wiring, fuses, circuit breakers, wiring voltage drop.
- Bad splitters or combiners, or these are used in an incorrect way.
- Part of the PV array not working.
- PV array design issues.
- Solar array configuration mistakes.
- The batteries are too small, or getting older, and have a reduced capacity.

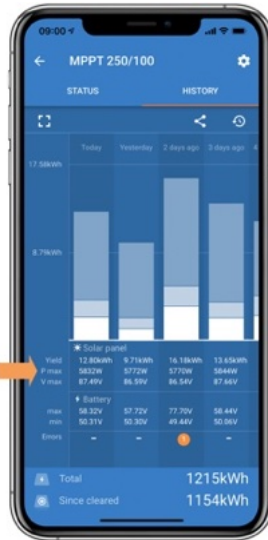

VictronConnect app history Pmax reading.

7.5.2. Full rated output not reached

There are a few reasons why the solar charger is not reaching its full rated output.

Some of these reasons have already been explained in the the chapter: "The batteries take too long to charge, are undercharged or charge current less than expected". Some additional reasons are explained in this paragraph.

PV Array too small

If the PV array power rating is less than the solar charger nominal power rating, the solar charger cannot output more power than the connected solar array can provide.

7.5.3. Mixed PV panel types

It is not recommended to connect a mix of different PV panel types to the same solar charger.

Only use solar panels that are the same brand, type and model.

7.5.4. MC4 connectors wrongly connected

For a detailed explanation of how to connect MC4 connectors, MC4 splitters and MC4 combiners, see the [Wiring unlimited book](#), chapter: "Solar panels".

7.5.5. PV connections burned or melted

Burned or melted PV cables or connections are generally not covered under warranty. In most case this is due to any of the following reasons:

Solar cable

- Cables with rigid core wire or rigid strands used.
- Cables where the core wire has been soldered.
- Cable too thin - remember that the current will be higher when the PV voltage is lower. For more information on cable thickness see the [Wiring Unlimited book](#).

MC4 terminals

- Current has exceeded 30A per connector pair.
- Incorrectly crimped MC4 connectors.
- Bad quality MC4 connectors used

7.5.6. Optimisers cannot be used

Do not use solar panels with optimisers together with the solar charger.

Nearly all optimisers contain an MPPT or other tracking mechanisms and this interferes with the MPPT algorithm in the solar charger.

7.6. Communication problems

This chapter describes issues that might arise when the Multi RS Solar is connected to the VictronConnect app, other Victron devices or third-party devices.

7.6.1. Bluetooth

Please note that it is highly unlikely that the Bluetooth interface is faulty. The problem is most likely caused by something else. Use this chapter to quickly rule out some of the common causes of Bluetooth issues.

For a full troubleshooting guide see the [VictronConnect manual](#).

- **Check if Bluetooth is enabled**

It is possible to enable/disable Bluetooth in the product settings. To re-enable:

Connect to the solar charger via the VE.Direct port.

Navigate to the controller settings and then to "product info".

Re-enable Bluetooth.

- **Check if the controller is powered-up**

Bluetooth is active as soon as the solar charger is powered-up.

- **Check that Bluetooth is in range**

In open space the maximum Bluetooth distance is about 20 meters. In a build-up area, inside a house, a shed, a vehicle or a boat this distance can be a lot less.

- **The Windows VictronConnect app does not support Bluetooth**

The Windows version of the VictronConnect app does not support Bluetooth. Use an Android, iOS or macOS device instead. Or alternatively connect using a [VE.Direct to USB interface](#).

- **The controller is missing in the VictronConnect app device list**

Some steps to try to resolve this issue are:

Press the orange refresh button at the bottom of the VictronConnect app device list and check if the solar charger is now listed. Only one phone or tablet can be connected to the solar charger at any given time. Make sure no other devices are connected and try again.

Try to connect to another Victron product, does this work? If that also does not work, there probably is an issue with the phone or tablet.

Rule out any issues with the phone or the VictronConnect app by using another phone or tablet and try again.

If still unresolved, refer to the [VictronConnect app manual](#).

- **PIN code lost**

If you have lost the PIN code, you will need to reset the PIN code to its default PIN code. This is done in the VictronConnect app:

Navigate to the device list of the VictronConnect app.

Enter the solar charger's unique PUK code as printed on its product information sticker.

Click on the option symbol next to the solar charger listing.

A new window will open which allows you to reset the PIN code back to its default: 000000.

- **How to communicate without Bluetooth**

In case Bluetooth is not functional, turned off or unavailable, the VictronConnect app can still communicate via the unit's VE.Direct port. Or, if the unit is connected to a GX device, the VictronConnect app can communicate via VRM. For more information see the [VictronConnect app](#) chapter.

7.6.2. VE.Direct port

These are not common and if this occurs it is probably due to one of these issues listed in this paragraph.

Physical cable connector or data port issues Try a different VE.Direct cable and see if the unit will now communicate. Is the connector inserted properly and deep enough? Is the connector damaged? Inspect the VE.Direct port, are there bent pins? If this is the case, use long nose pliers to straighten the pins, while the unit is unpowered.

Note, unlike most other Victron products it is not possible to connect the to a GX device (i.e. Cerbo GX) using the VE.Direct interface. You must use the VE.Can interface to connect to a GX device.

7.6.3. VE.Smart communication

The Multi RS Solar does not support VE.Smart networking.

7.7. Error code overview

Error 2 - Battery voltage too high:

This error will auto-reset after the battery voltage has dropped. This error can be due to other charging equipment connected to the battery or a fault in the charge controller.

Error 3, Error 4 - Remote temperature sensor failure:

Check if the T-sense connector is properly connected to a remote temperature sensor. Most likely cause: the remote T-sense connector is connected to the BAT+ or BAT- terminal. This error will auto-reset after proper connection.

Error 5 - Remote temperature sensor failure (connection lost):

Check if the T-sense connector is properly connected to a remote temperature sensor. This error will not auto-reset.

Error 6, Error 7 - Remote battery voltage sense failure:

Check if the V-sense connector is properly connected to the battery terminals. Most likely cause: the remote V-sense connector is connected in reverse polarity to the BAT+ or BAT- terminals.

Error 8 - Remote battery voltage sense failure (connection lost):

Check if the V-sense connector is properly connected to the battery terminals.

Error 11 - Battery high ripple voltage:

High DC ripple is usually caused by loose DC cable connections and/or too thin DC wiring. After the inverter has switched off due to high DC ripple voltage, it waits 30 seconds and then restarts.

After three restarts followed by a shutdown due to high DC ripple within 30 seconds of restarting, the inverter will shutdown and stops retrying. To restart the inverter, switch it Off and then On.

Continuous high DC ripple reduces the inverter life expectancy.

Error 17 - Controller overheated despite reduced output current:

This error will auto-reset after charger has cooled down. Check the ambient temperature and check for obstructions near the ventilation grilles,

Error 20 - Maximum Bulk-time exceeded:

The maximum bulk time protection is a feature that was in the chargers when they were just released (2015 or earlier) and later the feature was removed.

If you do see this error, then update to the latest firmware.

If you then still have the error, perform a reset to factory defaults of the configuration, and reconfigure the solar charger.

Error 22, Error 23 - Internal temperature sensor failure:

The internal temperature measurements are out of range.

Disconnect all wires, and then reconnect all wires, to restart the unit.

This error will not auto-reset.

If the error remains, please contact your dealer, there might be a hardware defect.

Error 27 - Charger short circuit:

This condition indicates an over-current condition on the battery side. It can occur when a battery is attached to the unit using a contactor. Or in case the charger starts up without a battery connected but connected to an inverter that has a large input capacitance.

This error will auto-reset. If the error does not auto-reset disconnect the charge controller from all power-sources, wait 3 minutes, and power up again. If the error persists the charge controller is probably faulty.

Error 29 - Overcharge protection:

This error will auto-reset once the battery voltage drops below the float voltage. To protect the battery from over-charging the battery is disconnected.

Possible causes:

- Over-sized PV array configuration, if there are too many panels in series the battery voltage cannot be reduced any further. Consider wiring more PV panels in parallel to reduce the voltage.
- Configuration issue, check if the battery settings match with the installation (especially absorption and float voltage settings).
- Another charger in the system raises the battery voltage above the expected level.

Error 33 - PV overvoltage:

This error will auto-reset after PV-voltage has dropped to safe limit. This error is an indication that the PV-array configuration with regard to open-circuit voltage is critical for this charger. Check configuration, and if required, re-organise panels.

Error 34 - PV overcurrent:

The current from the solar-panel array has exceeded the rated current limit. This error could be generated due to an internal system fault. Disconnect the charger from all power-sources, wait 3 minutes, and power-up again. If the error persists the controller is probably faulty, contact your dealer.

Error 35 - PV over power:

Please upgrade your firmware to at least v1.08 as the issues causing this error have been addressed.

If you are using firmware v1.08 or newer this error indicates that the internal dc voltage is too high. This error will auto-reset. If the error does not auto-reset disconnect the charge controller from all power-sources, wait 3 minutes, and power up again. If the error persists the charge controller is probably faulty.

Error 41 - Inverter shutdown (panel isolation resistance too low):

PV panel isolation resistance too low. Check the PV array cabling and panel isolation, the inverter restarts automatically once the issue is resolved.

Error 42 - Inverter shutdown (ground current too high >30mA):

The ground leakage current in the PV array exceeds the allowed 30mA limit. Check the PV array cabling and panel isolation. Check the installation and restart the unit using the power-switch.

Error 43 - Inverter shutdown (ground fault):

The voltage difference between Neutral and Ground is too high.

Inverter or Multi (not connected to the grid):

- The internal ground relay is activated but the voltage over the relay is too high. The relay might be damaged.

Multi (connected to the grid):

- The ground wire in the installation is not present or not connected properly.
- Line and Neutral are swapped in the installation.

This error will not auto-reset. Check the installation and restart the unit using the power-switch.

Error 50, Error 52 - Inverter overload, inverter peak current:

Some loads like motors or pumps draw large inrush currents in a start-up situation. In such circumstances, it is possible that the start-up current exceeds the over current trip level of the inverter. In this case the output voltage will quickly decrease to limit the output current of the inverter. If the over current trip level is continuously exceeded, the inverter will shut down: wait 30 seconds and then restart.

The Inverter can supply more power than the nominal power level for a short time. If the time is exceeded the inverter stops.

After three restarts followed by another overload within 30 seconds of restarting, the inverter will shutdown and remain off. To restart the inverter, switch it Off, then On.

If the error persists reduce the load on the AC out terminal by switching off or disconnecting appliances.

Error 51 -Inverter temperature too high:

A high ambient temperature or enduring high load may result in shut down to over temperature. Reduce load and/or move inverter to better ventilated area and check for obstructions near the fan outlets.

The inverter will restart after 30 seconds. The inverter will not stay off after multiple retries.

Error 53 - Inverter output voltage:

If the battery voltage is getting low and a large load is applied to the AC output the inverter is unable to maintain the proper output voltage. Recharge the battery or reduce the AC loads to continue operation.

Error 54 - Inverter output voltage:

If the battery voltage is getting low and a large load is applied to the AC output the inverter is unable to maintain the proper output voltage. Re-charge the battery or reduce the AC loads to continue operation.

If the error immediately pops up when switching on the inverter (without load) on a full battery the cause is most likely a broken replaceable internal fuse. Contact your Victron dealer for support.

Error 55, Error 56, Error 58 - Inverter self test failed:

The inverter performs diagnostic tests before it activates its output. In the case that one of these tests fails an error message is displayed and the inverter does not turn on.

First try to restart the inverter, by switching it Off, and then On. If error persists the inverter is probably faulty.

Error 57 - Inverter AC voltage on output:

There is already AC voltage on the AC out terminal before switching on the inverter. Check that the AC out is not connected to a mains outlet or to another inverter.

This error will not auto-reset. Check the installation and restart the unit using the power-switch.

Error 59 - AC-IN1 relay test fault:

Automatic checking of the disconnect means failure. This usually indicates a broken relay (sticky contact) in the AC input stage.

Error 65 - Communication warning:

Communication with one of the paralleled controllers was lost. To clear the warning, switch the controller off and back on again.

Error 66 - Incompatible device:

The controller is being paralleled to another controller that has different settings and/or a different charge algorithm.

Make sure all settings are the same and update firmware on all chargers to the latest version.

This error also appears if MPPTs are connected to a GX device while configured for a VE.Smart network. Disable the VE.Smart networking features and use DVCC on the GX instead.

[Further troubleshooting steps described here.](#)

Error 67 - BMS Connection lost:

This error shows when the charger is configured to be controlled by a BMS, but does not receive any BMS control messages. In that situation, the charger stops charging by reducing its output voltage to the battery base voltage. This is a safety mechanism, the reason to still enable the output is to allow a system to self-recover from a battery low situation.

Solar Chargers only show this error when there is solar power available and thus the device is ready to initiate charging. It does not show at night. And in case there is a permanent problem, the error will raise in the morning and clear at night, and so forth.

Solution: check the connection between the charger and the BMS.

How to reconfigure the charger to standalone mode

Our Chargers and Solar Chargers automatically configure themselves to be BMS-controlled when they are connected to one; either direct or via a GX Device. And that setting is semi-permanent: power cycling the charger will not reset it.

When removing charger from such system, and reusing it in a system without BMS, that setting needs to be cleared. Here is how to do that:

- Chargers with LCD display: go into the setup menu, and change setting 'BMS' from 'Y' to 'N' (setup item 31).
- Other chargers: reset the charger to factory defaults with VictronConnect, and then reconfigure it.

Error 69 - Network misconfigured:

Applies to Inverter RS and Multi RS models. Firmware versions 1.11 and higher.

This error indicates an issue in the configuration. There are units present on the same CAN bus that have different system configurations. Please ensure that all units are set to either "Single Phase" or "Three Phase" and all units are set to either "50Hz" or "60Hz". All units will remain off until the configuration is fixed, after which the units will resume operation.

Error 70 - Network misconfigured:

Applies to Inverter RS models. Firmware versions 1.11 and higher.

Inverter RS units cannot be paired with a Multi RS and/or Transfer Switch.

Error 71 - Network misconfigured:

Applies to Inverter RS and Multi RS models. Firmware versions 1.11 and higher.

There are units present with incompatible firmware on the can bus. Make sure that all units are updated to the same firmware version. All units will remain off until the firmwares are updated, after which the units will resume operation.

Error 72 - Phase rotation:

Applies to Inverter RS and Multi RS models. Firmware versions 1.12 and higher.

Check if the phase order is correct L1→L2→L3.

The inverters remain operational, they won't connect to the grid. Once the issue is resolved the units will connect.

Error 73 - Multiple AC inputs:

Applies to Inverter RS and Multi RS models. Firmware versions 1.12 and higher.

Per phase only one active connection to the grid is allowed, remove or switch off the redundant connection.

The inverters remain operational, they won't connect to the grid. Once the issue is resolved the units will connect.

Error 74 - Too many units in parallel:

Applies to Inverter RS and Multi RS models. Firmware versions 1.12 and higher.

The number of inverters in parallel doesn't match with the transfer capabilities of the ac input relay of the Multi RS or Transfer switch. Firmware v1.12 does not support parallel units and a grid connection, so any combination of a Multi RS with a grid connection with more than one unit in parallel will trigger this error code on the Multi RS. The Multi RS only supports 3 units in 3-phase configuration at the moment.

The inverters remain operational, they won't connect to the grid. Once the issue is resolved the units will connect.

Error 75 - Network misconfigured:

Applies to Multi RS models. Firmware versions 1.19 and higher.

Three phase operation is not yet certified in combination with the selected grid code.

The inverters remain operational, they won't connect to the grid.

Error 76 - Network incomplete:

Applies to Inverter RS and Multi RS models.

The inverters shut down because there are insufficient units to operate a networked setup. Check if all required units are powered on and that the CAN interface cables are connected properly. All units remain off until the installation is fixed, after which the units resume operation.

Related configuration settings in VictronConnect are "Prevent CAN network islanding" + "Number of inverters in the system" and "Continue with missing phase" in the System section.

Error 77 - Settings sync disabled

Applies to Inverter RS and Multi RS models. Firmware v1.29 and higher.

This is a warning that indicates a mixed configuration in a networked setup where system settings synchronisation is enabled on some devices but not on all units. The units that have the settings synchronisation disabled show this warning. The units remain operational, to clear the warning either enable or disable system settings synchronisation on all units.

Error 116 - Calibration data lost:

If the unit does not work and error 116 pops up as the active error the unit is faulty, contact your dealer for a replacement.

If the error is only present in the history data and the unit operates normally this error can be ignored safely.

Explanation: When the units power up for the very first time in the factory, it does not have calibration data and an error 116 is logged. Obviously this should have been cleared, but in the beginning units left the factory with this message still in the history data.

Error 117 - Incompatible firmware:

This error indicates that a firmware update did not complete, so the device is only partially updated. Possible causes are: device out of range when updating over the air, a cable got disconnected or power was lost during the update session.

To fix this the update needs to be retried, download the correct firmware for your device from the [Victron Professional Portal](#).

When your GX device is connected to VRM, you can do a remote firmware update using this firmware file. You can do this via the VRM website or using the VRM tab in VictronConnect. VictronConnect can also be used together with the firmware file to update using a Bluetooth connection.

The procedure to add the file to VictronConnect and start the update is described here: [9. Firmware updates](#).

Error 119 - Settings data lost:

The charger cannot read its configuration, and stopped.

This error will not auto-reset. To get it working again:

1. First, restore it to factory defaults. (top right in Victron Connect, click on the three dots).
2. Disconnect the charge controller from all power-sources.
3. Wait 3 minutes, and power up again.
4. Reconfigure the charger.

Please do report this to your Victron dealer and ask him to escalate it to Victron; as this error should never happen. Preferably include firmware version and any other specifics (VRM URL, VictronConnect screenshots or similar).

Error 121 - Tester fail:

If the unit does not work and error 121 pops up as the active error the unit is faulty, contact your dealer for a replacement.

If the error is only present in the history data and the unit operates normally this error can be ignored safely. Explanation: when the units powers up for the very first time in the factory, it does not have calibration data and an error 121 is logged. Obviously this should have been cleared, but in the beginning units left the factory with this message still in the history data.

Error 200 - Internal DC voltage error:

The unit performs internal diagnostics when activating its internal DC-DC converter. This error indicates that something is wrong with the DC-DC converter.

This error will not auto-reset. Check the installation and restart the unit using the power-switch. If the error persists the unit is probably faulty.

Error 201 - Internal DC voltage error:

Applies to the MPPT RS, Inverter RS and Multi RS.

This "Internal DC voltage measurement error", is raised in case an internal (high) voltage measurement does not match certain criteria.

First, make sure to update the firmware to v1.08 or later. The limits were too strict in earlier versions. And it could trigger falsely during MPPT start-up in the morning and MPPT shutdown in the evening.

If the error still occurs after updating to v1.08 or later, then it means that a measurement circuit inside the unit is broken.

This error will not auto-reset. Check the installation and restart the unit using the power-switch. If the error persists, even after above mentioned firmware update, the unit is most likely faulty and must be sent in for repair/replacement.

Error 202 - Internal GFCI sensor error:

The sensor used to measure residual current did not pass the internal self test. This error will not auto-reset. Check the installation and restart the unit using the power-switch.

If the error persists the unit is probably faulty and must be sent in for repair/replacement.

Error 203, Error 204, Error 212, Error 215 - Internal supply voltage error:

The unit performs internal diagnostics when activating its internal voltage supplies. This error indicates that something is wrong with an internal supply voltage.

This error will not auto-reset. Check the installation and restart the unit using the power-switch. If the error persists the unit is probably faulty.

8. Technical Specifications

Multi RS Solar 48/6000/100-450/100 - PMR482602020	
PowerControl & PowerAssist	Yes
Transfer Switch	50 A
Maximum AC input and pass-through current	50 A
INVERTER	
DC Input voltage range (1)	38 – 62V
AC Output (2)	Output voltage: 230 Vac \pm 2% Frequency: 50 Hz \pm 0,1% (1) Maximum continuous inverter current : 25 Aac
Continuous output power at 25°C	Increases linearly from 4600 W at 46 VDC to 5200 W at 52 VDC
Continuous output power at 40°C	4500W
Continuous output power at 65°C	3000W
Peak power (3)	9 kW for 3 seconds 7 kW for 4 minutes
Short-circuit output current	45 A
Max. AC output overcurrent protection	30 A
Maximum efficiency	96.5% at 1 kW load 94% at 5 kW load
Zero load power	20W
Low battery shutdown	37.2 V (adjustable)
Low battery restart	43.6 V (adjustable)
SOLAR	
Maximum DC voltage (4)	450 V
Start-up voltage	120 V
MPPT voltage range	65 – 450 V
Maximum operational PV input current limit	12 A
Max. PV short circuit current	16 A
Maximum DC solar charging power	6000 W total - 3000 W per tracker
Earth leakage trip level	30 mA
Isolation fail level (detection before start-up)	100 k Ω
CHARGER	
AC Input	Input voltage range: 187-265 VAC Input frequency: 45-65 Hz Nominal Voltage 230 Vac Nominal frequency: 50 Hz AC inrush current: NA
Icw and Ipk requirements	Icw: 500A @ 0.1s and Ipk: 2kA
Programmable charger voltage range (5)	36 - 60 V

Multi RS Solar 48/6000/100-450/100 - PMR482602020	
Charge voltage 'absorption'	default: 57.6 V (adjustable)
Charge voltage 'float'	default: 55.2 V (adjustable)
Maximum charge current from AC (6)	88 A @ 57.6V
Total maximum combined charger current (AC + PV)	100 A
Battery temperature sensor	Included
Battery voltage sense	Yes
GENERAL	
Parallel and 3-phase operation	3 Phase supports 1 unit per phase. Parallel not supported.
Auxiliary output (AC-out-2) (7)	Yes
Programmable relay (8)	Yes
Protection (9)	a - g
Data Communications (10)	VE.Direct port, VE.Can port & Bluetooth
Bluetooth frequency	2402 - 2480 MHz
Bluetooth power	4 dBm
General purpose analog/digital in port	Yes, 2x
Remote on-off	Yes
Operating temperature range	-40 to +65°C (fan assisted cooling)
Maximum altitude	2000 m
Humidity (non-condensing)	max 95%
Earthing system	TN, TT only
ENCLOSURE	
Material & Color	steel, blue RAL 5012
Protection category	IP21 Protective Class: I
Battery-connection	M8 Bolts
PV Connection	2 strings, each with positive and negative MC4
230 V AC-connection	Screw terminals 10 mm ² (6 AWG)
Weight	12.3 kg
Dimensions (hxwx d)	462 x 425 x 127 mm
STANDARDS	
Safety	EN-IEC 60335-1, EN-IEC 60335-2-29, EN-IEC 62109-1, EN-IEC 62109-2 IEC 62040, IEC 62477
Emission, Immunity	EN 55014-1, EN 55014-2 EN-IEC 61000-3-2, EN-IEC 61000-3-3 IEC 61000-6-1, IEC 61000-6-2, IEC 61000-6-3 Pollution Degree 2
Overvoltage Category	Battery: OVC I PV port: OVC II AC in / AC out: OVC III
UPS Specification	Input: 230VAC, 46A, 50Hz Output: 230VAC, 26A, 50Hz, 6kVA / 5kW Protective device (input and output): Max 50A circuit breaker

Multi RS Solar 48/6000/100-450/100 - PMR482602020

- 1) Minimum start-up voltage is 41 VDC. Over-voltage disconnect: 65,5 V.
- 2) Can be adjusted to 240VAC and 60 Hz
- 3) Peak power capacity and duration depends on start temperature of heatsink. Mentioned times are with cold unit.
- 4) The maximum PV voltage should not exceed 8x battery float voltage. E.g. If the battery voltage is 50 V, the maximum PV voltage should not exceed $8 \times 50 = 400$ V.
- 5) The Charger set points (float & absorption) can be set to max 60 V. The output voltage at the charger terminals can be higher due to compensation for temperature & voltage drop over the battery cables. The maximum output current is reduced on a linear basis from full current at 60 V to 5A at 62 V. The equalization voltage can be set to max 62V, the equalization current percentage can be set to max 6%.
- 6) The maximum charge current from AC sources depends on input voltage and battery current. At 230V input and 57.6V battery voltage, and 25C ambient, the maximum charge current is 88A. See manual, limitations section, for further details.
- 7) AC-out-2 is connected directly to the AC input and intended for non-critical loads. The AC-out-2 load is taken into account by PowerControl & PowerAssist.
- 8) Programmable relay which can be set for general alarm, DC under voltage or genset start/stop function. DC rating: 4 A up to 35 VDC and 1 A up to 70 VDC
- 9) Protection key: a) output short circuit b) overload c) battery voltage too high d) battery voltage too low e) temperature too high f) 230 VAC on inverter output g) solar earth leakage.
- 10) Not currently compatible with VE.Smart Networks. Connection to a GX device (i.e. Cerbo GX) must be made via the VE.Can interface. The VE.Direct interface is for connection to the GlobalLink 520.
- 11) Connectivity to the Victron VM-3P75CT energy meter must be made via VE.Can or Ethernet. Avoid intermediate Wi-Fi links between the energy meter and the GX device, as Wi-Fi can introduce latency and reduce reliability.

9. Appendix

9.1. Appendix A : Connection Overview

Figure 1. Multi RS Solar Front

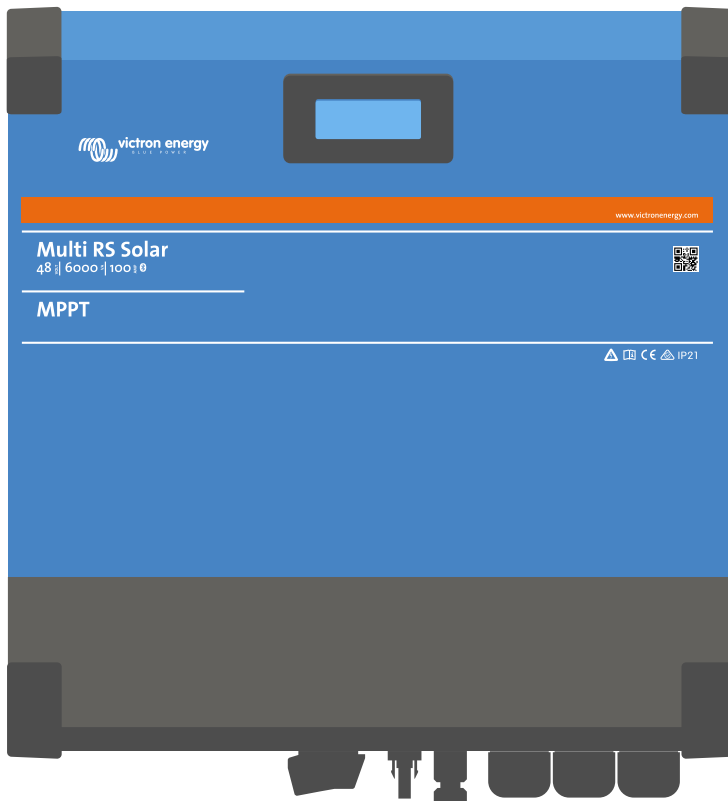

Figure 2. Multi RS Solar Bottom

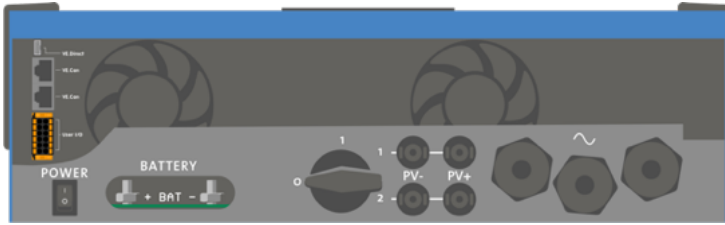
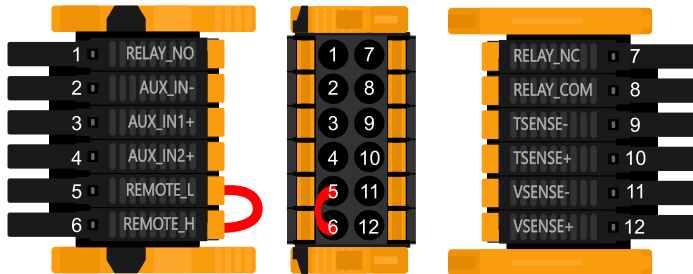

Figure 3. User I/O



User I/O Connector is located on bottom left side of connection area, diagram shows 3 perspectives. Left Side - Top - Right Side

Table 2. User I/O Functions - See Installation Section for more details.

Number	Connection	Description
1	Relay_NO	Programmable relay Normally Open connection
2	AUX_IN -	Common negative for programmable auxiliary inputs
3	AUX_IN1+	Programmable auxiliary input 1 positive connection
4	AUX_IN2+	Programmable auxiliary input 2 positive connection
5	REMOTE_L	Remote on/off connector Low
6	REMOTE_H	Remote on/off connector High
7	RELAY_NC	Programmable relay Normally Closed connection
8	RELAY_COM	Programmable relay common negative
9	TSENSE -	Temperature Sensor negative
10	TSENSE +	Temperature Sensor positive
11	VSENSE -	Voltage Sensor negative
12	VSENSE +	Voltage Sensor positive

9.2. Appendix B : Block Diagram

Figure 4. Multi RS Solar

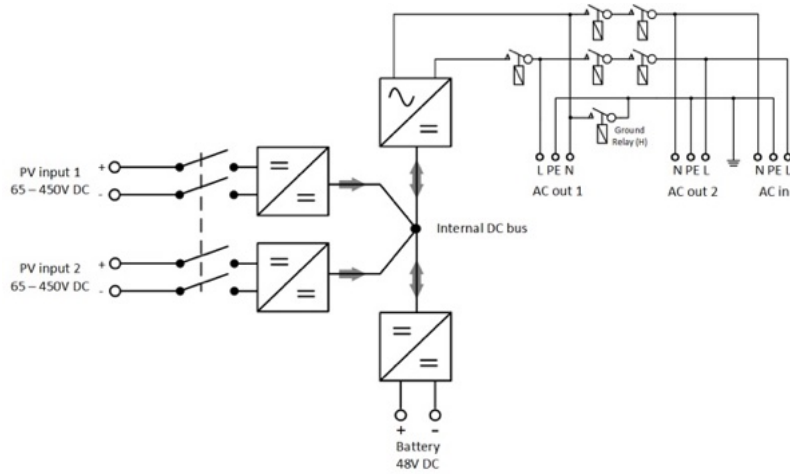

9.3. Appendix C : Example Wiring Diagram

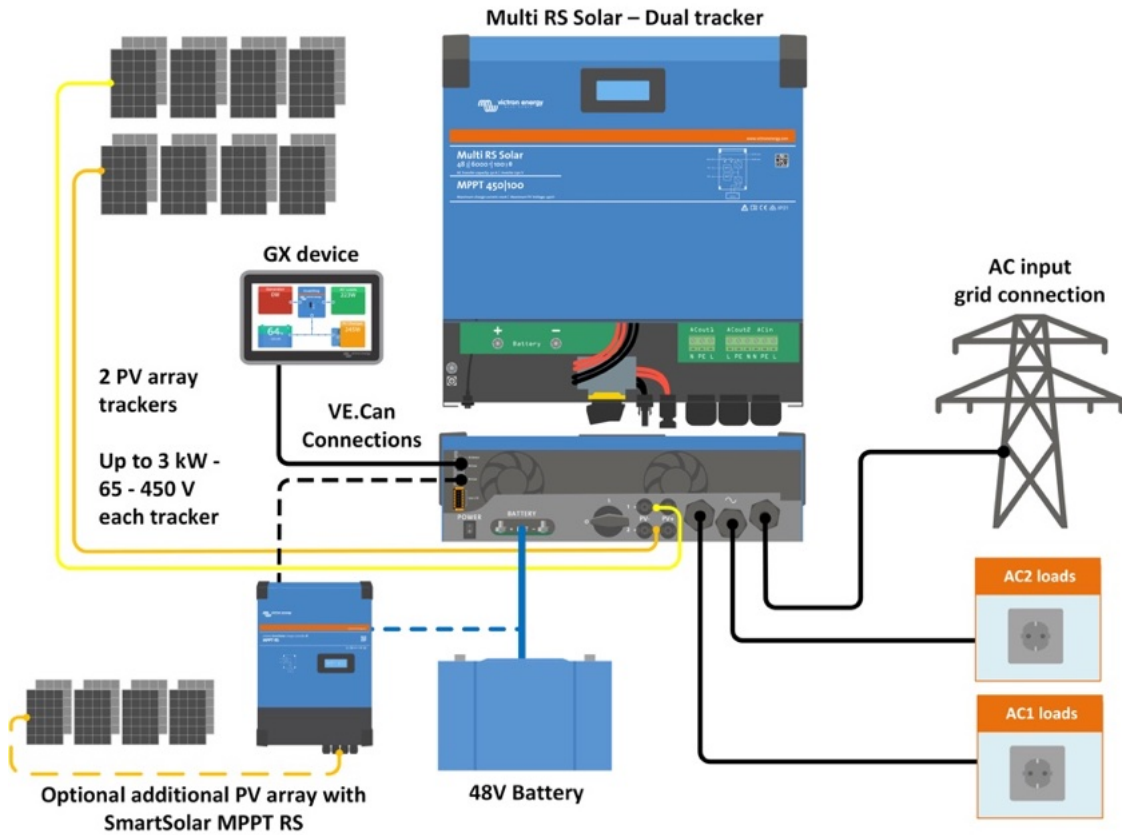
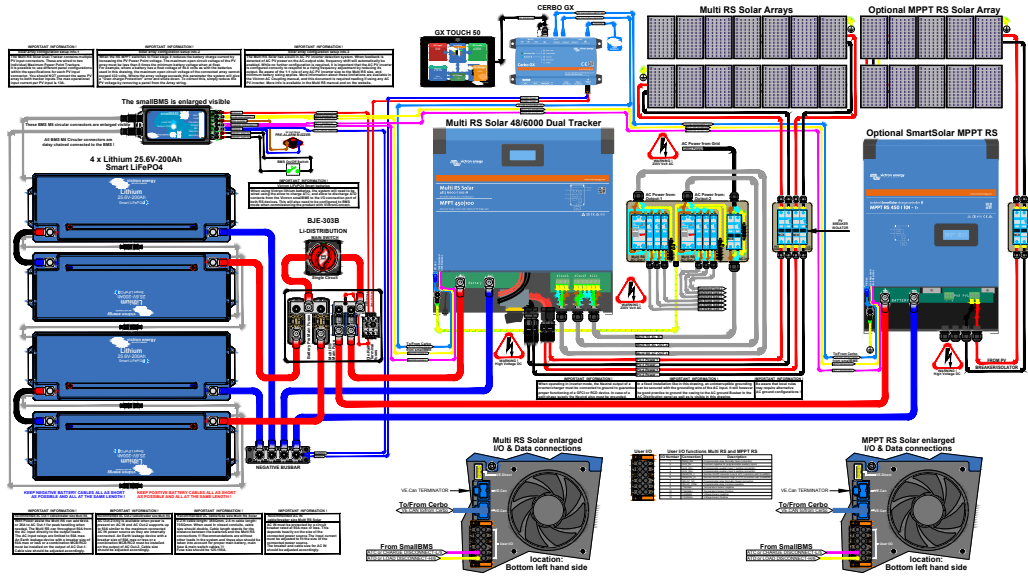

Figure 5. Multi RS Solar full wiring diagram



See here for highest resolution and most up-to-date schematics - <https://www.victronenergy.com/inverters-chargers/multi-rs-solar#system-schematic>

9.4. Appendix D : Dimensions

Figure 6. Multi RS Solar

